



Dear **International Fuel Ethanol Workshop & Expo 2017** Exhibitor:

This Exhibitor Service Kit details important information to allow Valley Expo & Displays, Show Decorator, to help ensure your success at the **International Fuel Ethanol Workshop & Expo 2017**, at the **Minneapolis Convention Center, June 19 - 21, 2017**.

VALLEY ONLINE ORDERING

For your convenience Valley Expo & Displays offers online ordering.

You can order your Valley services, view show schedule, and review your account information.

To place online orders you will be required to register with Valley Online.

If you received this Exhibitor Service Kit in an email, a direct link and your temporary password to online ordering were also included. Click on the link to be directed to our website and begin ordering. (<https://valleyexpodisplays.boomerecommerce.com>)

If you did not receive an email, visit, www.valleyexpodisplays.com. Click on "Register and get your Password Here" to request your online credentials. Fill out the required information and submit.

Once your request is processed you will receive an email with your login information. It may take up to two hours to generate your credentials. We appreciate your patience in advance.

HELPFUL HINTS

Order early and take advantage of the advance pricing to receive discounted rates.

Ship early to avoid delays. Shipments arriving late at show site will cost you money, time and business.

Please read each form carefully, and return them to the address shown on each form. Other suppliers may be used for some services (i.e. electrical) and orders with payment should be sent separately to them for those services.

Valley Expo & Displays does not take orders over the phone. All orders must be entered online (<https://valleyexpodisplays.boomerecommerce.com>) faxed (815-873-1544) or, emailed (events@valleyexpodisplays.com) by **June 12, 2017**.

Valley Expo & Displays will accept no orders without payment in full.

Please contact our *Exhibitor Services Department* at 877.332.4292, with any questions you may have.

Thank you for your business and we look forward to seeing you at the show!





International Fuel Ethanol Workshop & Expo 2017
Minneapolis Convention Center, June 19 - 21, 2017

GENERAL

General Show information Page 1

BBI INTERNATIONAL

Exhibitor Rules and Regulations Pages 2,3

BOOTH SPECIAL

Booth Package Special Order Form Page 4

PAYMENT-CREDIT CARD AUTHORIZATION

ReCap of Cost & Payment (Credit Card Auth) Page 5

THIRD PARTY/EXHIBITOR APPOINTED CONTRACTOR

Third Party Billing Page 6

Exhibitor Appointed Contractor Page 7

Official Contractors Information Page 8

BOOTH FURNITURE AND CARPET

Booth Furniture Order Form Page 9

Grid Wall Order Form Page 10

Booth Carpet Order Form Page 11

SHIPPING

Shipping Information Page 12

Advance Shipment Labels Page 13

Direct Shipment Labels Page 14

UPS Freight Trade Show Services Information Pages 15, 16

Freight Services Information Page 17

Special Handling Definitions Page 18

Freight Handling Order Form Page 19

Freight Service Questionnaire--**Must Complete** Page 20

VEHICLE PLACEMENT

Vehicle Placement Order Form Page 21

PORTABLE MODULAR DISPLAY RENTAL

Portable Modular Display Rental Order Form Page 22

Exhibit Options by Valley Expo & Displays & Nomadic Display Pages 23-29

LABOR

Event Labor Order Form Page 30

Supervised Labor Installation & Dismantle Order Form Page 31

Forklift Service Order Form Page 32

Hanging Sign Order Form Page 33, 34

Hanging Sign Shipment Labels Page 35

SIGN & BANNER

Sign & Banner Order Form Page 36

SHOW SITE UNION RULES

Union Rules - Minneapolis Page 37

PLANT & FLORAL

Plant & Floral Order Form Page 38

AFR FURNISHINGS

AFR Furnishings Catalog Pages 39-68

AFR Furnishings Price List & Order Form Pages 69-73

MINNEAPOLIS CONVENTION CENTER FORMS

Electrical Service Order Form Pages 74-76

Internet/Network/Telephone Service Order Form Pages 77-80

Cleaning & Porter Service Order Form Pages 81-83

Compressed Air, Water, Drain & Gas Service Order Form Pages 84-86

Guest & Security Services Order Form Pages 87-89

AV & Computer Service Order Form Page 90





Register Here for Online Ordering...
www.valleyexpodisplays.com
 EMAIL: EVENTS@VALLEYEXPDISPLAYS.COM
 FAX: 815.873.1544

GENERAL SHOW INFORMATION

International Fuel Ethanol Workshop & Expo 2017
Minneapolis Convention Center, June 19 - 21, 2017

ADVANCED PRICE DEADLINE:
 May 26, 2017

Valley Expo & Displays is the official general service contractor for this event. We will have clearly identifiable representatives on the show floor during set up to answer your questions. Prior to set up, please direct your questions to our exhibitor services department in our main office listed below. Our goal is to help you make your participation in this event a success!

This **Exhibitor Information Packet** contains shipping instructions for this event. **You can guarantee a smooth installation by completing these forms and sending them with payment to Valley Expo & Displays as soon as possible.**

Please read each form carefully, and return them to the address shown on **each** form. Sometimes other suppliers are used for some services (i.e.: electrical), and orders with payment should be sent separately to them for those services.

Please note: *We strongly recommend that you pay for your services in advance using a credit card. This allows your representative at the show site to order additional needed furniture and equipment without having to arrange for payment on the show floor. Valley Expo & Displays will accept no orders without payment in full.*

Official Contractor:	Valley Expo & Displays 4950 American Road Rockford, IL 61109	phone: (877) 332-4292 fax: (815) 873-1544 e-mail: events@valleyexpodisplays.com
-----------------------------	--	--

Booth Package: A standard 10' x 10' booth will include:

Green/White 8' Back Drape and White 3' Side Drape
 (1) 7" x 44" Identification Sign

Your exhibit area is **NOT** carpeted with facility carpet. Aisles are carpeted in pepper color carpet.

**** all exhibit areas are required to have a floor covering****

Additional equipment and services may be ordered using the attached forms.

Important Schedule Information:

Rates for freight handling, forklift and labor related with move-in are now the same on Sunday & Monday to better accommodate those who wish to move-in over the weekend. Please take advantage of these savings!

Advance Price Deadline:	Friday	May 26, 2017	
Exhibitor Move In:	Sunday	June 18, 2017	8:00AM - 5:00PM
	Monday	June 19, 2017	8:00AM - 12:00PM
Show Hours:	Monday	June 19, 2017	5:00PM - 6:30PM
	Tuesday	June 20, 2017	11:00AM - 6:30PM
	Wednesday	June 21, 2017	7:30AM - 1:30PM
Exhibitor Move Out:	Wednesday	June 21, 2017	1:30PM - *6:30PM

*Carriers must check in by 3:30PM

All the information you need is contained on the attached forms. If at any time you have questions, please call our Exhibitor Services Department at (877) 332-4292.





Exhibitor Rules & Regulations

Booth Construction

All booth displays must be constructed so as to appear “finished” on all sides that may be visible, including from all adjoining booths. For example, if the framework structure of a pop-up booth is visible from an adjoining booth, that framework will need to be covered so as to not detract from the appearance of the adjoining booth. All exhibit displays should be designed and erected in a manner that will withstand normal contact or vibration caused by neighboring exhibitors, hall laborers or installation/dismantling equipment such as forklifts.

Line of Sight

All exhibitors are entitled to a reasonable line of sight which varies by booth size and location. Generally, nothing should be over four feet (4') tall in the three feet (3') closest to the aisle. Regardless of the number of standard booths utilized, (e.g. 10'x20', 10'x30', 10'x40' etc.) display materials should be arranged in such a manner so as to not obstruct sight lines of neighboring exhibitors. The maximum height of eight feet (8') is allowed only in the rear of the booth space, with a four foot (4') height restriction imposed on all materials in the three feet closest to the aisle.

Standard Booth

A standard booth consist of an area 10'x 10'x8' high. All display material over four feet (4') high, must be set back three feet (3') from the main aisle.

Endcap Booth

An endcap booth is a 10'x20'x10' high booth exposed to aisles on three sides. The back wall is restricted to four feet (4') high within the three feet (3') closest to each aisle permitting adequate line of sight for the adjoining booths. The rest of the back wall can be no higher than ten feet (10'). Any portion of the back wall that extends beyond the eight foot (8') curtain must be finished (no exposed framing or structure) and may not carry any ad copy on the back side.

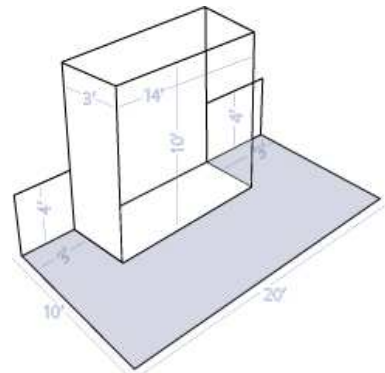

Split Endcap Booth

A Split Endcap is a 10'x20'x10' high booth exposed to aisles on three sides and shares a common back wall with another Endcap booth. In both cases, the entire cubic content of the booth may be used. Any portion of the back wall that extends beyond the eight foot (8') curtain must be finished (no exposed framing or structure) and may not carry any ad copy.

Peninsula Booth

Peninsula booths are any configuration of four or more booths exposed to aisles on three sides. Peninsula Booths are 20'x20'x16' high or larger. When a Peninsula booth backs up to two Standard Booths, the back wall is restricted to four feet (4') high within the three feet (3') closest to each aisle, in the back five feet (5') of the booth permitting adequate line of sight for the adjoining booths. The rest of the back wall can be no higher than sixteen feet (16'). Any portion of the back wall that extends beyond the eight foot (8') curtain must be finished (no exposed framing or structure) and may not carry any ad copy on the back side.

**Island Booth/Split Island Booth**

An Island booth is exposed to aisles on all four sides. A Split Island Booth is a Peninsula Booth which shares a common back wall with another Peninsula Booth. In both cases, the entire cubic content of the booth may be used up to sixteen feet (16'). Any portion of the back wall within five feet (5') of booth perimeter that extends beyond the eight foot (8') curtain must be finished (no exposed framing or structure) and may not carry any ad copy.

Balloons

Helium balloons may be used as booth decorations if securely fastened within the height restrictions of booth type, but balloon distribution is prohibited.

Audio-Video/Music/Loud Demonstrations

Expo management reserves the right to limit or restrict sounds from any source that interfere with activities in neighboring exhibits. In general, sounds should be no louder than 85 decibels. As a matter of safety and courtesy to others, exhibitors should conduct sales presentations and product demonstrations in a manner which assures all exhibitor personnel and attendees are within the contracted exhibit space and not encroaching on the aisle or neighboring exhibits. It is the responsibility of each exhibitor to arrange displays, product presentation and demonstration area to ensure compliance. Special caution should be taken when demonstrating machinery or equipment that has moving parts or any product that is potentially dangerous. Exhibitors should establish a minimum setback of three feet (3') and/or install hazard barriers as necessary to prevent accidental injury to spectators. Demonstrations involving sound need to be limited in frequency and are at the discretion of show management. Generally, a neighbor across the aisle should not be able to hear your demonstration.

Hanging Signs and Graphics

Whether suspended from above or supported from below, they should comply with all ordinary use-of-space requirements. The highest point of any sign in any booth should not exceed the maximum allowable height for that type of booth. Hanging signs and graphics should be set back a minimum of five feet (5') from adjacent booths and aisles. Multi-sided signs, projection screens or logos may not face an adjacent booth. This will include back walls, side panels, headers and towers.

Floor Coverings

All exposed floor area contained within the booth must be covered with carpet or other appropriate floor coverings.

Variance

Height variance fee is \$100. Expo management, in its sole discretion, may make exceptions to the height restrictions for some exhibitors as it considers advisable. Any exhibitor requesting a variance must submit the request in writing along with written approval from the exhibitors affected by the variance. Please send requests to jgerman@bbiinternational.com.

VALLEY
EXPO & DISPLAYS
 BETTER IDEAS. BETTER RESULTS.
 valleyexpodisplays.com



Register Here for Online Ordering...
 www.valleyexpodisplays.com
 EMAIL: EVENTS@VALLEYEXPODISPLAYS.COM
 FAX: 815.873.1544

**BOOTH
 PACKAGE**

BOOTH PACKAGE
 PRICE DEADLINE:
 May 12, 2017

International Fuel Ethanol Workshop & Expo 2017
Minneapolis Convention Center, June 19 - 21, 2017

Your FEW 2017 booth space does not include a furniture package. Valley Expo & Displays is offering a discounted furniture package to all FEW exhibitors at the rate listed below. In order to receive the discounted rate, all FEW exhibitors must complete this form and fax back to Valley by **May 12, 2017 (this date differs from the Advanced Price Deadline Date)**.

Special Booth Package	Quantity	Show Special	Total
(1) 8' L x 30" H Skirted Table (2) Side Chairs		\$ 217.05	\$

Subtotal \$ _____
 7.775% Sales Tax \$ _____
 Total \$ _____

Skirted Table Color Selection: Blue Silver Black White

ORDER WITH PAYMENT MUST BE RECEIVED BY MAY 12, 2017

Please provide the following information so we may credit your account properly.

Company Name _____ Booth # _____ Date _____

Billing Address _____ City & State _____ Zip _____

E-Mail Address _____ Name (please print) _____

Phone _____ Fax _____ Check No. (if paying by check) _____

___ Visa ___ MC ___ Amex Card Number _____ Exp. Date ___/___ CVC2 _____
3 digit or 4 digit code

(SIGNATURE REQUIRED BELOW ON ANY CREDIT CARD CHARGES)

X _____
 Cardholder Signature Cardholder's Name (please print)

BOOTH NUMBER: _____

COMPANY NAME: _____





Register Here for Online Ordering...
 www.valleyexpodisplays.com
 EMAIL: EVENTS@VALLEYEXPDISPLAYS.COM
 FAX: 815.873.1544

**RECAP OF
 COST &
 PAYMENT**

ADVANCED PRICE DEADLINE:
 May 8, 2015

International Fuel Ethanol Workshop & Expo 2017
Minneapolis Convention Center, June 19 - 21, 2017

One copy of this form with your credit card information, and all applicable order forms must be forwarded to Valley Expo & Displays at the address below. Advance prices apply only to orders received with payment in full by the advance price deadline date listed on the General Show Information sheet. All orders received afterward, or at the show site will be subject to floor rates. **We cannot accept phone orders**, however, you may fax your order to us, provided we have your complete, valid credit card information. No invoice or statement will be issued.

For your convenience, when you pay with a credit card, any additional charges incurred for equipment and services will be billed to your card. In any event, no services will be rendered until payment in full has been received.

Exhibitors who have applied for special billing considerations, and to whom credit is extended agree to pay as a service charge 1 - 1/2% per month (18% per annum) and to pay all costs of collection, including a reasonable attorney's fee on all charges not paid within 30 days of invoice date. Payment for labor and services ordered by the exhibitor, their display house or other third parties is the responsibility of the exhibitor. The undersigned (jointly or severally) hereby does primarily and unconditionally guarantee the payment and discharge at maturity of each and every obligation incurred by this designate or assigns (display house or third party agent) in such transaction and agrees in the event of default by such third party of any such obligation to pay and otherwise make good on demand by Valley Expo & Displays or its assigns at any time thereafter, any sums and obligations then owing by the exhibitor to Valley Expo & Displays. **50% Surcharge on all refunds. No refunds will be issued after 14 days from the last day of the event. NO EXCEPTIONS!**

Please complete all the blanks below:

SERVICES AND EQUIPMENT ORDERED

- \$ _____ Booth Package Order Form
- \$ _____ Booth Furniture Order Form
- \$ _____ Grid Wall Order Form
- \$ _____ Booth Carpet Order Form
- \$ _____ Freight Handling Order Form
- \$ _____ Portable/Modular Display Rental Order Form
- \$ _____ Event Labor Order Form
- \$ _____ Forklift Service Order Form
- \$ _____ Hanging Sign Order Form
- \$ _____ Sign & Banner Order Form

\$ _____ **Total Now Due**

Please provide the following information so we may credit your account properly.

Company Name	Booth #	Date
Billing Address	City & State	Zip
E-Mail Address	Name (please print)	
Phone	Fax	Check No. (if paying by check)

Visa MC Amex Card Number _____ Exp. Date ____/____ CVC2 _____
(SIGNATURE REQUIRED BELOW ON ANY CREDIT CARD CHARGES)

 Cardholder Signature Cardholder's Name (please print)

Please retain copies of all paperwork...Final invoices will be emailed after the show.



BOOTH NUMBER:

COMPANY NAME:

VALLEY
EXPO & DISPLAYS
 BETTER IDEAS. BETTER RESULTS.
 valleyexpodisplays.com



Register Here for Online Ordering...
 www.valleyexpodisplays.com
 EMAIL: EVENTS@VALLEYEXPDISPLAYS.COM
 FAX: 815.873.1544

**THIRD
 PARTY
 BILLING**

International Fuel Ethanol Workshop & Expo 2017
Minneapolis Convention Center, June 19 - 21, 2017

This form is to be used if you wish to have a Third Party handle your display, and be billed for services.

The Recap of Costs Payment Form should be completed by the Third Party to be billed for services, **however, we must also be provided with the Exhibiting Company's credit card information below for our files.** Unless otherwise requested, all charges incurred will be billed to the Third Party.

It should be understood that by signing this form or placing an order the Exhibiting Company agrees it is ultimately responsible for payment of charges. **If your Third Party does not pay all charges in full before the end of the show, all charges will revert to the exhibiting company, due on receipt.**

All information below must be completed by the respective parties:

Third Party Information

 Third Party

 Billing Address

 City State Zip

 Phone Fax

X

 Authorized Signature

 Print Authorized Name

 EMAIL ADDRESS

Exhibiting Company Information

 Exhibiting Company

 Billing Address

 City State Zip

 Phone Fax

X

 Authorized Signature

 Print Authorized Signature

 EMAIL ADDRESS

Please indicate any services that should **not** be billed to the Third Party:

Exhibiting Company's credit card information:

___ Visa ___ MC ___ Amex ___ / ___ Exp. Date ___ CVC2
Last 3 digits on back of card, 4 digits on front of AMX

Account #: _____

X

 Cardholder's Signature

 Print Cardholder's Name

 Cardholder's Billing Address

 City

 State

 Zip



VALLEY
EXPO & DISPLAYS
 BETTER IDEAS. BETTER RESULTS.
 valleyexpodisplays.com



Register Here for Online Ordering...
 www.valleyexpodisplays.com
 EMAIL: EVENTS@VALLEYEXPDISPLAYS.COM
 FAX: 815.873.1544

**EXHIBITOR
 APPOINTED
 CONTRACTOR**

International Fuel Ethanol Workshop & Expo 2017

Minneapolis Convention Center, June 19 - 21, 2017

AUTHORIZATION FORM

NAME OF SHOW _____

COMPANY NAME _____

ADDRESS _____

(STREET)

(CITY)

(STATE)

(ZIP)

PHONE # _____ FAX # _____

ORDERED BY _____ TITLE _____

SIGNATURE _____ DATE _____

E-MAIL ADDRESS _____

If your company plans to use a contractor, which is not the official service contractor as designated by Show Management, please complete this form and mail to the address listed above.

Company Name: _____ Booth No: _____

Contact At Show: _____

Exhibitor Appointed Contractor: _____

Address of Contractor: _____

Phone Number of Contractor: _____

Email Address of Contractor: _____

Type of Service to be performed: _____

Inform your **Exhibitor Appointed Contractor** that they **must** send a copy of their General Liability Insurance Certificate no later than **30 days** prior to the first day of exhibitor move-in or they will not be permitted to service your exhibit.

It is the responsibility of the exhibitor to see that each representative of an Exhibitor Appointed Contractor abides by the official rules and regulation of this event.

This form must be received 30 DAYS PRIOR TO THE FIRST DAY OF EXHIBITOR MOVE-IN.

BOOTH NUMBER: _____

COMPANY NAME: _____





International Fuel Ethanol Workshop & Expo 2017

Minneapolis Convention Center, June 19 - 21, 2017

EXHIBITOR APPOINTED CONTRACTORS

Exhibitors may employ the service of independent contractors to install and dismantle their display, providing the Exhibitor and the installation and dismantling contractor comply with the following requirements:

1. The exhibitor must notify Show Management and Valley Expo & Displays of the intention to utilize an independent contractor no later than 30 days prior to the first day of move-in, furnishing the name, address and telephone number of the firm.
2. The Exhibitor shall provide evidence that the Exhibitor Appointed Contractor has proper certificates of insurance with at least the minimum as described below, unless Show Management requires more.
 - a. Comprehensive General Liability not less than \$1,000,000 with respect to injuries to any one person in an occurrence.
 - b. \$2,000,000 with respect to injuries to more than one person in any occurrence.
 - c. Workers' Compensation Insurance including employee liability coverage in the minimum amount not less than \$1,000,000 of individual and/or aggregate coverage and/or statutory limitation.
 - d. **Valley Expo & Displays and Show Management must be named as additional insureds.**
3. The exposition floor, aisles, loading docks, service and storage areas will be under the control of the Official Service Contractor, Valley Expo & Displays.
4. For services such as electrical, plumbing, telephone, and cleaning and drayage, no contractor other than the Official Service Contractor will be approved. This regulation is necessary due to licensing, insurance, and work done on equipment and facilities owned by parties other than the Exhibitor. Exhibitors shall provide only the material and equipment they own and is to be used in their exhibit space.
5. The Exhibitor Appointed Contractor:
 - a. Must agree to abide by all rules and regulations of the show, as outlined in this exhibitor kit, including all union rules and regulations.
 - b. Will share with Valley Expo & Displays all reasonable costs related to its operation, including but not limited to overtime pay for stewards, restoration of exhibit space to its initial condition.
 - c. Must furnish Show Management and Valley Expo & Displays with the names of all on-site employees who will be working on the exposition floor and see that they have and wear at all times necessary identification badges as determined by Show Management.
 - d. Shall be prepared to show evidence that it has a valid authorization from the Exhibitor for services. The exhibitor Appointed Contractor may not solicit business on the exhibit floor.
 - e. Must confine its operations to the exhibit area of its clients. No service desks, storage areas, or other work facilities will be located anywhere in the building. The show aisles and public space are not a part of the Exhibitor's booth space and must be kept clear.
 - f. Shall provide, if requested, evidence to Valley Expo & Displays that it possesses applicable and current labor contracts and must comply with all labor agreements and practices. The Exhibitor Appointed Contractor must not commit or allow to be committed by persons in its employment any acts could lead to work stoppages, strikes, or labor problems.
 - g. Must coordinate all of its activities with Valley Expo & Displays.
 - h. Must comply with all reasonable rules and regulations of the venue, Show Management and Official Service Contractor in order to create a safe work environment. A failure to do so can result in a delay or termination of your right to continue if the condition cannot be corrected.
6. All information must be received by Valley Expo & Displays' office no later than 30 days prior to the first day of move-in.



International Fuel Ethanol Workshop & Expo 2017

Minneapolis Convention Center, June 19 - 21, 2017

 ADVANCED PRICE DEADLINE:
 May 26, 2017

Orders with payment in full must be received by **May 26, 2017**, for Advance Prices.

All orders subject to availability of equipment. Prices include delivery to booth, set up and removal. All equipment remains property of Valley Expo & Displays. No orders will be accepted without payment in full. **Orders refused after delivery to booth will be subject to a 100% service charge. Thank you for your order!**

Be sure to indicate skirting color. Orders received without color indicated will receive Foreman's choice.

Skirting Color Selection: Blue White Gold Green Black Burgundy Red Teal Silver Purple

Skirted Tables	Quantity	Advance	Floor	Total
4' L x 30" H		\$ 127.90	\$ 166.30	
6' L x 30" H		\$ 151.85	\$ 197.45	
8' L x 30" H		\$ 170.60	\$ 211.80	
4' L x 42" H		\$ 134.20	\$ 174.50	
6' L x 42" H		\$ 163.20	\$ 212.20	
8' L x 42" H		\$ 194.60	\$ 253.00	

Plain Tables	Quantity	Advance	Floor	Total
4' L x 30" H		\$ 57.35	\$ 74.60	
6' L x 30" H		\$ 84.40	\$ 109.75	
8' L x 30" H		\$ 101.15	\$ 131.50	
4' L x 42" H		\$ 77.60	\$ 100.90	
6' L x 42" H		\$ 103.95	\$ 135.15	
8' L x 42" H		\$ 120.10	\$ 156.15	
30" x 13' Skirting Only (4th Side)		\$ 62.10	\$ 80.75	
42" x 13' Skirting Only (4th Side)		\$ 71.85	\$ 93.45	
White Table Vinyl, 8' Long		\$ 11.90	\$ 15.50	

Cocktail Tables	Quantity	Advance	Floor	Total
30" Round, 30" High		\$ 96.90	\$ 126.00	
30" Round, 42" High		\$ 105.10	\$ 136.65	

Chairs	Quantity	Advance	Floor	Total
Side Chair		\$ 50.35	\$ 65.50	
Padded Chair		\$ 64.80	\$ 84.25	
Bar Stool with Back		\$ 81.60	\$ 106.10	

Miscellaneous	Quantity	Advance	Floor	Total
Tripod Adjustable Easel		\$ 33.05	\$ 43.00	
Wastebasket		\$ 15.00	\$ 19.50	
Garment Rack		\$ 37.30	\$ 48.50	
Bag Stand		\$ 80.70	\$ 104.95	
3' Drape (Side) per LnFt		\$ 9.20	\$ 12.00	
8' Drape (Back) per LnFt		\$ 13.05	\$ 17.00	
Literature Stand		\$ 174.55	\$ 226.95	
Table Riser 1' x 1' x 4 White Skirted		\$ 71.05	\$ 92.40	
Posterboard 4' x 8' Horizontal/Vertical (circle one)		\$ 220.45	\$ 268.60	

Subtotal

7.25 % Sales Tax

Total

BOOTH NUMBER:

COMPANY NAME:





International Fuel Ethanol Workshop & Expo 2017
Minneapolis Convention Center, June 19 - 21, 2017

 ADVANCED PRICE DEADLINE:
 May 26, 2017

Orders with payment in full must be received by **May 26, 2017**, for Advance Prices. All orders subject to availability of equipment. Prices include delivery to booth, set up and removal. All equipment remains property of Valley Expo & Displays. No orders will be accepted without payment in full. **Orders refused after delivery to booth will be subject to a 100% service charge. Thank you for your order!**

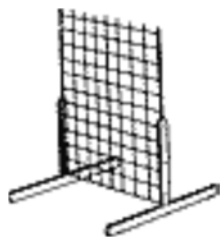
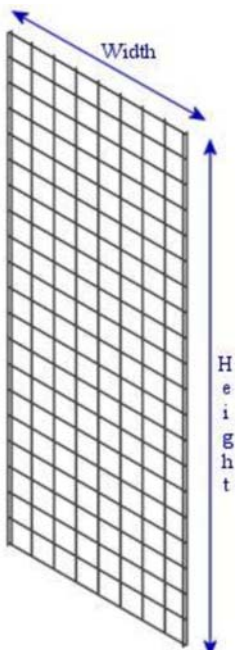
Item Description	Quantity	Advanced Pricing	Floor Pricing	Total
PANELS				
2' w x 4' h Panel		\$ 36.40	\$ 47.35	
2' w x 6" h Panel		\$ 42.15	\$ 54.80	
2' w x 8' h Panel		\$ 53.45	\$ 69.50	
BASES				
"T" Base, per set		\$ 25.05	\$ 32.60	
SHELVES				
24" w/shelf brackets		\$ 13.75	\$ 17.90	
48" w/shelf brackets		\$ 19.40	\$ 25.25	
MOUNTING				
6 Ball Waterfall		\$ 9.15	\$ 11.90	
Hang Rail		\$ 10.30	\$ 13.40	
Picture Hanger		\$ 2.40	\$ 3.15	
Hat Display		\$ 5.75	\$ 7.50	
Peg Hook (4", 6", 12")		\$ 2.40	\$ 3.15	
			Subtotal	
			7.25% Sales Tax	
			Order Total	\$



"T" Base



Picture Hanger

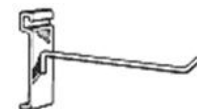

Peg Hook



Hat Display



6 Ball Waterfall



Hang Rail



Shelf



VALLEY
EXPO & DISPLAYS
 BETTER IDEAS. BETTER RESULTS.
 valleyexpodisplays.com



Register Here for Online Ordering...
www.valleyexpodisplays.com
 EMAIL: EVENTS@VALLEYEXPDISPLAYS.COM
 FAX: 815.873.1544

**BOOTH
 CARPET**

International Fuel Ethanol Workshop & Expo 2017

Minneapolis Convention Center, June 19 - 21, 2017

ADVANCED PRICE DEADLINE:
 May 26, 2017

Orders with payment in full must be received by **May 26, 2017**, for Advance Prices.

All orders subject to availability of equipment. Prices include delivery to booth, set up and removal. All equipment remains property of Valley Expo & Displays. No orders will be accepted without payment in full. **Orders refused after delivery to booth will be subject to a 100% service charge. Thank you for your order!**

Standard carpet rental includes installation, front edge taping and pickup at the close of the show. If carpet is ordered in multiples of two or more, the carpets are not guaranteed to be a color match. **Carpet orders received without color indicated will receive Foreman's choice.**

Crown Jewel 18 Color Selection: Blue Green Black Burgundy Red Gray

Crown Jewel 18 Carpet	Quantity	Advance	Floor	Total
10' x 10'		\$ 205.10	\$ 266.65	
10' x 20'		\$ 411.00	\$ 534.30	
10' x 30'		\$ 616.00	\$ 800.80	
Additional taping per foot	LnFt	\$ 1.70	\$ 2.25	

Carpet price includes taping front aisle edge only

Crown Jewel 18 Custom Color Selection: Blue Green Black Burgundy Red Gray

Crown Jewel Custom Carpet - Booths Larger than 30'	Quantity	Advance	Floor	Total
Carpet Size _____ x _____ =	SqFt	\$ 4.45	\$ 5.80	

Custom size booth carpet is available in 10' widths only. This carpet is cut specifically to your booth measurements. Rental includes installation, all necessary taping, and pick up at the close of the show. Include a layout for carpet installation if your carpet is different from your booth size. If you require additional carpet to cover steps, skids, or display fixtures, please include a floorplan and a quotation will be forwarded to your before we proceed.

Designer Plus 28 Color Selection: Blue Green Black Burgundy Red Gray Silver Cloud White

Designer Plus 28 Booth Carpet	Quantity	Advance	Floor	Total
Carpet Size _____ x _____ =	SqFt	\$ 4.75	\$ 6.20	

This luxurious carpet is cut specifically to your booth measurements. Rental includes installation, all necessary taping, plastic covering for your protection and pickup at the close of the show. Include a layout for carpet installation if your carpet is different from your booth size. If you require additional carpet to cover steps, skids, or display fixtures, please include a floorplan and a quotation will be forwarded to your before we proceed. Purchase options are available. Samples are available upon request.

Foam Padding and Visqueen	Quantity	Advance	Floor	Total
Padding	SqFt	\$ 1.70	\$ 2.25	
Visqueen	SqFt	\$ 0.75	\$ 1.00	

Subtotal

7.25% Sales Tax

Total

BOOTH NUMBER:

COMPANY NAME:





Register Here for Online Ordering...
www.valleyexpodisplays.com
 EMAIL: EVENTS@VALLEYEXPDISPLAYS.COM
 FAX: 815.873.1544

SHIPPING INFORMATION

International Fuel Ethanol Workshop & Expo 2017 Minneapolis Convention Center, June 19 - 21, 2017

Please read this information carefully, and call us if you have questions.

Freight Handling Charges: Valley Expo & Displays is prepared to receive your freight in advance at one of our warehouse locations, or directly at the show site. **All shipments must be sent prepaid; collect freight shipments will be refused.** Valley Expo freight handling charges are based on incoming weight, rounded up to the nearest 100 lbs. For rates and schedule information that apply to this convention, please refer to the **Freight Handling Order Form**.

Exhibitors are responsible for crating and uncrating of their own product.

Advance Shipments:

- A. Receiving at our warehouse up to 30 days prior to the first day of move in
- B. Delivery to your exhibit booth
- C. Storage of empty containers, and return of empty containers to your booth
- D. Reloading freight for outbound shipping

Please complete your bill of lading, and label your shipment as follows:

EXHIBITING COMPANY NAME BOOTH NUMBER International Fuel Ethanol Workshop & Expo 2017 YRC FREIGHT C/O VALLEY EXPO & DISPLAYS 12400 DUPONT AVENUE SOUTH BURNSVILLE, MN 55337

First day freight will be accepted at advance location: **5/19/17**

Last day freight will be accepted: **6/14/17**

Direct Shipments to the Show Site:

- A. Receiving at the show site, and delivery to your exhibit booth
- B. Storage of empty containers
- C. Return of empty containers to your booth
- D. Reloading for outbound shipment

EXHIBITING COMPANY NAME BOOTH NUMBER International Fuel Ethanol Workshop & Expo 2017 MINNEAPOLIS CONVENTION CENTER C/O VALLEY EXPO & DISPLAYS 1301 2ND AVENUE SOUTH MINNEAPOLIS, MN 55403
--

Please complete your bill of lading, and label your shipment as follows:

Do not send shipments to arrive in advance of 6/18/17 to the show site. The facility has no means of storage, and will refuse your shipment.

Days freight will be accepted at show site: **6/18/17; 8:00AM - *5:00PM**
6/19/17; 8:00AM - *12:00PM

***Drivers must check in by 4:00PM on 6/18 and by 11:00AM on 6/19**

Authorization To Provide Freight Services: By completing the Freight Handling Order Form, it is understood that Valley Expo & Displays and its subcontractors do not automatically insure materials, that insurance, if any, shall be arranged by the Exhibitor and the amounts payable to Valley Expo & Displays for drayage services are based on the value of the material handling services and the scope of Valley Expo & Displays liability as herein set forth. The amounts payable to Valley Expo & Displays are unrelated to the value of the Exhibitor's property being handled by Valley Expo & Displays or its subcontractor. It is impractical and extremely difficult to fix the value of each shipment handled by Valley Expo & Displays or its subcontractors. It is agreed therefore that if Valley Expo & Displays or its subcontractors should be found liable for loss or damage to Exhibitor's materials, the liability shall be limited to the specific article that was physically lost or damaged. Such liability shall be limited to a sum equal to 30 cents per pound per article, with a maximum liability of \$500 per item, or \$1,000 per shipment, whichever amount shall be less, as agreed upon damages bit as a penalty, and such agreed upon damages shall be the Exhibitors exclusive remedy. Exhibits left on exhibit floor without return instructions will be returned to our warehouse and held for disposition at an additional charge. Valley Expo & Displays will not be responsible for condition, count or content until such time as exhibits or materials are picked up for removal after the close of the exhibition.

Make certain all your material is properly insured against fire, theft and all hazards while in transit to and from your booth and for the duration of the exhibition.

The Freight Handling Order Form must be completed and returned with payment to Valley Expo & Displays before exhibit freight will be handled!



<h1>RUSH</h1>
EXHIBITOR MATERIAL

FROM:

ADVANCE SHIPMENT

TO: _____
 EXHIBITING COMPANY

International Fuel Ethanol Workshop & Expo 2017
 SHOW NAME

_____ *BOOTH NUMBER*

C/O VALLEY EXPO & DISPLAYS
 YRC TRANSPORTATION
 12400 DUPONT AVENUE SOUTH
 BURNSVILLE, MN 55337

Shipment Should Arrive Between:
 May 19, 2017 thru June 14, 2017

CERTIFIED WEIGHT TICKETS ARE REQUIRED FOR ALL SHIPMENTS.

Carrier _____
 Number _____ of _____ pieces

<h1>RUSH</h1>
EXHIBITOR MATERIAL

FROM:

ADVANCE SHIPMENT

TO: _____
 EXHIBITING COMPANY

International Fuel Ethanol Workshop & Expo 2017
 SHOW NAME

_____ *BOOTH NUMBER*

C/O VALLEY EXPO & DISPLAYS
 YRC TRANSPORTATION
 12400 DUPONT AVENUE SOUTH
 BURNSVILLE, MN 55337

Shipment Should Arrive Between:
 May 19, 2017 thru June 14, 2017

CERTIFIED WEIGHT TICKETS ARE REQUIRED FOR ALL SHIPMENTS.

Carrier _____
 Number _____ of _____ pieces

<h1>RUSH</h1>
EXHIBITOR MATERIAL

FROM:

DIRECT SHIPMENT

TO: _____
EXHIBITING COMPANY

International Fuel Ethanol Workshop & Expo 2017

SHOW NAME

BOOTH NUMBER

C/O VALLEY EXPO & DISPLAYS
MINNEAPOLIS CONVENTION CENTER
1301 SECOND AVENUE SOUTH
MINNEAPOLIS, MN 55403

Shipment Should Arrive:

June 18, 2017; 8:00AM – 5:00PM

June 19, 2017; 8:00AM – 12:00PM

CERTIFIED WEIGHT TICKETS ARE REQUIRED FOR ALL SHIPMENTS.

Carrier _____
Number _____ of _____ pieces

<h1>RUSH</h1>
EXHIBITOR MATERIAL

FROM:

DIRECT SHIPMENT

TO: _____
EXHIBITING COMPANY

International Fuel Ethanol Workshop & Expo 2017

SHOW NAME

BOOTH NUMBER

C/O VALLEY EXPO & DISPLAYS
MINNEAPOLIS CONVENTION CENTER
1301 SECOND AVENUE SOUTH
MINNEAPOLIS, MN 55403

Shipment Should Arrive:

June 18, 2017; 8:00AM – 5:00PM

June 19, 2017; 8:00AM – 12:00PM

CERTIFIED WEIGHT TICKETS ARE REQUIRED FOR ALL SHIPMENTS.

Carrier _____
Number _____ of _____ pieces



Exhibit Services

Reliable trade show shipping services





The show must go on!

YRC Freight is ready to customize transportation solutions for any exhibit shipment, any size load, delivering great service, savings and simplicity.

After the show, specify YRC Freight for the move out on the materials handling agreement (MHA), then give us a call. We'll take it from there.

And if others handle your trade show shipping, remember to tell them about YRC Freight savings and service.

Delivering confidence at the show

- 100% inbound service guarantee* at no additional cost
- On-site Exhibit managers monitor your inbound shipments for on-time, smooth move ins
- Time-Critical expedited
- Comprehensive North American coverage and online visibility

Giving you more for your money

- Lowest trade show shipping fees in the industry
- 30 days free storage prior to the show; a great way to save when moving from show to show
- No detention fees at trade shows
- No extra fees for weekend/after-hour pickups

Keeping it simple for you

- Exhibit customer service representatives available 24/7; call 1-800-531-EXPO (3976)
- Around-the-clock assistance with quotes, bookings, tracking or expediting
- Single-shipment transportation for your entire display
- Online shipment visibility throughout the move on my.yrcfreight.com

* Subject to applicable Tariffs and Rules and Conditions publications.

Confidence Delivered.®

yrcfreight.com | 800.531.EXPO (3976) |  Live Chat



International Fuel Ethanol Workshop & Expo 2017

Minneapolis Convention Center, June 19 - 21, 2017

As the official service contractor, Valley Expo & Displays is the exclusive provider of freight services. Material handling includes unloading your exhibit material, storing up to 30 days in advance at the warehouse address, delivering to the booth, the handling of empty containers to and from storage, and removing of material from the booth for reloading onto outbound carrier. It should not be confused with the cost to transport your exhibit material to and from the convention or event. You have two options for shipping your advance freight—either to the warehouse or directly to show site (if applicable).

Shipping to the Advanced Warehouse

- We may accept freight up to 30 days prior to show move-in. Please check the Freight Handling page for specific dates.
- To ensure timely arrival of your materials at show site, freight should arrive by the deadline date listed on the Shipping Information page. Your freight will still be received after the deadline date, but additional charges will be incurred.
- The warehouse will receive shipments Monday through Friday, except holidays.
- The warehouse will accept crates, cartons, skids, trunks/cases and carpets. Loose or pad-wrapped material must be sent directly to show site.
- All shipments must have a bill of lading or delivery slip indicating the number of pieces, type of merchandise and weight.
- Certified weight tickets must accompany all shipments.
- Warehouse freight will be delivered to the booth prior to exhibitor setup.
- Please call our Exhibitor Services Department at 877.332.4292 if you want to ship oversized material that requires special equipment to the warehouse.

Shipping to Show Site

- Please refer to the Shipping Information page for the specific dates and times direct freight will be accepted.
- All shipments must have a bill of lading or delivery slip indicating the number of pieces, type of merchandise and weight.
- Certified weight tickets must accompany all shipments.

Prepaid or Collect Shipping Charges

- Collect shipments will be returned to the delivery carrier.
- To ensure that your freight does not arrive collect, mark your bill of lading "prepaid".
- "Prepaid" designates that the transportation charges will be paid by the exhibitor or a third party.

Labeling Your Freight

- The label should contain the exhibiting company name, the booth number and the name of the event.
- The specific shipping address for either the advance warehouse or show site is located on the Shipping Information page.

Estimating Material Handling Charges

- Charges will be based on the weight of your shipment. Each shipment received is considered separately. The shipment weight will be rounded to the next 100 lbs. Each 100 lbs. is considered one "cwt" (one hundred weight). All shipments are subject to reweigh.
- On the Freight Handling order form, select whether the freight will arrive at the warehouse or be sent directly to show site (if applicable).
- Next, select the category that best describes your shipment. There are three categories of freight:
 - Crated:** material that is skidded or is in any type of shipping container that can be unloaded at the dock with no additional handling required.
 - Special Handling:** material delivered by the carrier in such a manner that it requires additional handling, such as ground loading, stacked or constricted space, unloading, designated piece unloading, loads mixed with pad-wrapped material, loads failing to maintain shipping integrity, carpet or labor to unload. **Federal Express, UPS Ground, and DHL** are included in this category due to their delivery procedures.
 - Uncrated:** material that is shipped loose or pad-wrapped, and/or unskidded machinery without proper lifting bars or hooks.
- Add overtime charges for inbound if material is delivered to the booth during the overtime period. This includes both warehouse and show-site shipment.
- Add overtime charges for outbound if material is loaded onto the outbound carrier during the overtime period.
- Add the late delivery charge listed on the Freight Handling order form if material is loaded onto the outbound carrier during the overtime period.
- Add the late delivery charge listed on the Freight Handling order form if the shipment is accepted at the warehouse or at show site after the deadline date.
- Shipments received without receipts or freight bills, such as UPS and Federal express, will be delivered to the booth without guarantee of piece count or condition.

Empty Containers

- Pick up "Empty Labels" at the Valley Service Desk. Place a label on each container. Labeled containers will be picked up periodically and stored in a non-accessible storage during the show.
- At the close of the show, the empty containers will be returned to the booth in random order. Depending on the size of the show, this process may take several hours.

Protecting Materials

- Consistent with trade show industry practices, there may be a lapse of time between the delivery of your shipment(s) to your booth and your arrival. The same is true for the outbound phase of the show-time between your departure and the actual pickup of your materials. During these times, your materials will be left unattended. We recommend that you arrange for a representative to stay with your materials or that you hire security services to safeguard your materials.

Shipping Materials After the Close of Show

- Each shipment must have a completed Bill of Lading in order to ship materials from the show. All pieces must be labeled individually. Bill of Ladings are available at the Valley Service Desk at show site.
- After materials are packed, labeled and ready to be shipped, the completed Bill of Lading must be turned in at Exhibitor Services. Do not leave this in your booth with your shipment.
- Call your designated carrier with pick-up information. Please refer to the General Information page for specific dates and times. In the event your carrier fails to show on final move-out day, your shipment will be rerouted to Valley Expo & Displays' carrier of choice at exhibitor's expense.
- For your convenience, the show-recommended carrier may be on site to handle outbound transportation.

VALLEY
EXPO & DISPLAYS
 BETTER IDEAS. BETTER RESULTS.
valleyexpodisplays.com



Register Here for Online Ordering...
www.valleyexpodisplays.com
 EMAIL: EVENTS@VALLEYEXPODISPLAYS.COM
 FAX: 815.873.1544

**SPECIAL
HANDLING**

International Fuel Ethanol Workshop & Expo 2017

Minneapolis Convention Center, June 19 - 21, 2017

Special handling applies to shipments that are loaded by cubic space and/or packed in such a manner as to require additional labor/handling, such as ground loading, constricted space loaded, designated piece unloading, carpet/pad only shipments or stacked shipments. Also included are shipment integrity, alternate delivery locations, mixed shipments and shipments without individual bills of lading. Shipments loaded in this manner require additional time, labor, or equipment to unload, sort and deliver.

Ground Loading/Unloading

Vehicles that are not dock height, preventing the use of loading docks, such as U-hauls, flat bed trailers, double drop trailers, company vehicles with trailers that are not at dock level, etc.

Constricted Space Loading/Unloading

Trailer loaded "high and tight" shipments that are not easily accessible. Freight is loaded to full capacity of trailer—top to bottom, side to side. One example of this is freight loaded down one side of a trailer that must be by-passed to reach target freight.

Designated Piece Loading/Unloading

Drivers that require the loading crew to bring multiple pieces of the freight to the rear of the trailer to select the next piece, having to remove freight from the trailer then reload to fit the trailer that must be loaded in a sequence to ensure all items fit.

Stacked Shipments

Shipments loaded in such a manner requiring multiple items to be removed to ground level for delivery to booth. Stacked or "cubed out" shipments, loose items placed on top of crates and/or pallets constitute special handling.

Shipment Integrity

Shipment integrity involves shipments on a carrier that are intermingled, or delivered in such a manner that additional labor is needed to sort through and separate the various shipments on a truck for delivery to our customers.

Alternate Delivery Location

Alternate Delivery Location refers to shipments that are delivered by a carrier that requires us to deliver some shipments to different levels in the same building or to other buildings in the same facility.

Mixed Shipments

Mixed shipments are defined as shipments of mixed crated and uncrated goods, where the percentage of uncrated is minimal and does not warrant the full uncrated rate for the shipment, but does require special handling. Valley defines special handling for mixed loads as having less than 50% of the volume as uncrated.

No Documentation

Shipments arrive from a small package carrier (including, among others, Federal Express, UPS Ground, Airborne Express and DHL) without an individual Bill of Lading, requiring additional time, labor and equipment to process.

Carpet Only Shipments

Shipments that consist of carpet and/or carpet padding only require special handling because of additional labor and equipment to unload.

Crated vs. Uncrated Shipments

Crated shipments are those that are packed in any type of shipping container that can be unloaded at the dock with no additional handling required. Such containers include crates, fiber cases, cartons, and properly stacked skids. An uncrated shipment is material that is shipped loose or pad wrapped, and/or unskidded without proper lifting bars and hooks.





Register Here for Online Ordering . . .
 www.valleyexpodisplays.com
 EMAIL: EVENTS@VALLEYEXPDISPLAYS.COM
 FAX: 815.873.1544

**FREIGHT
HANDLING**

International Fuel Ethanol Workshop & Expo 2017
Minneapolis Convention Center, June 19 - 21, 2017

This Freight Handling Form must be completed and returned with payment to Valley Expo & Displays before your freight will be handled. Immediately upon shipping, please forward a copy of your freight bill of lading to us. Exhibitor shipments by carriers not giving delivery receipts or bill of lading, such as UPS, FedEx or US Postal Service, will be accepted and delivered to your booth space with no guarantee of piece count or condition. No liability whatsoever will attach to Valley Expo & Displays for those shipments. Valley Expo & Displays assumes no liability for lost or damaged items stored during any event.

FREIGHT HANDLING SERVICES

- Crated:** Material that is skidded or is in any type of shipping container that can be unloaded at the dock with no additional handling required.
- Special Handling:** Material delivered by a carrier in such a manner that it requires additional handling, such as ground unloading, stacked or constricted space unloading, designated piece unloading, shipment integrity, alternate delivery location, loads mixed with pad wrapped material, carpet and/or pad only shipments, no documentation and shipments that require additional time, equipment or labor to unload. **Federal Express, UPS, Airborne Express & DHL** are included in this category due to their delivery procedures.
- Uncrated:** Material that is shipped loose or pad-wrapped, and/or skidded machinery without proper lifting bars or hooks.
- Surcharge:** All material delivered to your booth after 5PM on June 18 & Noon on June 19 are subject to a 20% surcharge.

WAREHOUSE SHIPMENT (200lbs. Minimum Per Shipment)					
Valley is unable to receive flatbed shipments or any single piece weighting over 5,000 pounds at the Advance Warehouse.					
Crated or Skidded Shipment			Special Handling Shipment		
Rate Classification	Per CWT	200lbs Min.	Rate Classification	Per CWT	200lbs Min.
Standard Rate	\$112.55	\$225.10	Standard Rate	\$146.20	\$292.40
Shipments delivered to the Warehouse after deadline date of 6/14/2017 will incur a \$20.05 surcharge per CWT					

SHOWSITE SHIPMENT (200lbs. Minimum Per Shipment)								
Crated or Skidded Shipment			Special Handling Shipment			Uncrated or Pad Wrapped Shipment		
Rate Classification	Per CWT	200lbs Min	Rate Classification	Per CWT	200lbs Min	Rate Classification	Per CWT	200lbs Min
Standard Rate	\$119.50	\$239.00	Standard Rate	\$155.15	\$310.30	Standard Rate	\$172.70	\$345.40
Shipments delivered to the Show Site after deadline date of 6/19/2017 will incur a \$22.80 surcharge per CWT								

SMALL PACKAGE (Maximum weight is 50lbs. Per Shipment)	
First Carton	Each Additional Carton
\$66.55	\$16.45
Shipments delivered after deadline date listed above, will incur a \$11.70 surcharge for the first carton and \$2.90 for each additional carton	

Please understand that your calculation is only an estimate. Invoicing will be done from the actual weight. Adjustments will be made accordingly.

SMALL PACKAGE - ESTIMATE OF FREIGHT HANDLING CHARGES				
Total # of Carton in Shipment	TOTAL ESTIMATE			
_____ First Carton + _____ # of Additional Cartons =	\$ _____			
ESTIMATE OF FREIGHT HANDLING CHARGES (200LBS MINIMUM PER SHIPMENT)				
Shipment Will Be Sent To	Approximate Weight of Shipment (rounded to the nearest 100)	X CWT (Weight of Shipment ÷ 100 = CWT)	+ Additional Surcharges	TOTAL ESTIMATE
<input type="checkbox"/> Warehouse	LBS.			\$ _____
<input type="checkbox"/> Show site				

Special Note: Shipping to the Advanced Warehouse will ensure your move in goes smoothly and stays within the move in times of 8am-5pm on June 18 and 8am-noon on June 19 and to avoid additional surcharges outside of these move in times.

Outbound shipments from your booth: Exhibitor routings on outbound shipments will be honored when possible. However, we reserve the right to reroute as necessary. All outbound shipments must be tendered with a Bill of Lading. If you prefer to assign your own carrier to handle outbound shipping, you must have your carrier check-in by the designated time. Copies of any outbound shipping forms should be left at our service desk. In the event the designated carrier fails to pick up by the specified time, such shipments will be rerouted by Valley Expo & Displays. Specified (freight force) time can be obtained at the Valley Service Desk or by calling customer service.

**** In any event, do not simply abandon your freight! Our representative on site must be given the appropriate paperwork and outbound shipping instructions****



BOOTH NUMBER: _____
COMPANY NAME: _____



International Fuel Ethanol Workshop & Expo 2017
Minneapolis Convention Center, June 19 - 21, 2017

**ALL EXHIBITORS SHIPPING FREIGHT
MUST RETURN THIS FORM**

1. Estimate total number of pieces being shipped:

- _____ Crated
- _____ Uncrated
- _____ Machinery
- _____ Total

2. Indicate total number of trucks in each category that you will use:

- _____ Van Line
- _____ Common Carrier
- _____ Flatbed
- _____ Company Truck
- _____ Overseas Container

3. List carrier name(s):

4. If using a Customs Broker, please print name:

Phone _____

5. Print the name of person in charge of your move-in:

Phone _____

6. What is the minimum number of days required to set your displays?

7. What is the weight of the single heaviest piece that must be lifted?

_____ Lbs.

8. What is the total weight of your exhibit or equipment being shipped?

_____ Lbs.

9. Is there any special handling equipment required to unload your exhibit materials, i.e. extended forklift blades, special slings, lifting bars, etc.?

It is the responsibility of the Exhibitor to provide proper special handling instructions. Failure to provide these instructions will result in the elimination of any liability for loss or damage by Valley Expo & Displays.

DIRECT SHIPMENTS ONLY:

1. What date and time are you scheduling your shipment(s) to arrive on-site?

BOOTH NUMBER: _____
COMPANY NAME: _____





Register Here for Online Ordering...
www.valleyexpodisplays.com
 EMAIL: EVENTS@VALLEYEXPDISPLAYS.COM
 FAX: 815.873.1544

VEHICLE PLACEMENT ORDER FORM

International Fuel Ethanol Workshop & Expo 2017
Minneapolis Convention Center, June 19 - 21, 2017

Valley Expo & Displays charges a round-trip fee of **\$243.40** per vehicle to place a vehicle on the tradeshow floor. It is understood that this will apply to rolling stock, self-propelled, towed and/or pushed vehicles/machinery. Valley personnel will receive equipment at show site and drive to the exhibitor booth. We will also handle the outbound as an inclusive service.

The City Fire Marshall requires disconnecting the battery, sealing the gas tank and placing a protective covering under the vehicle. Check local Fire Marshal rules and regulations for additional requirements.

Be advised that if you are planning to display a vehicle, you are required to provide the information listed on this page.

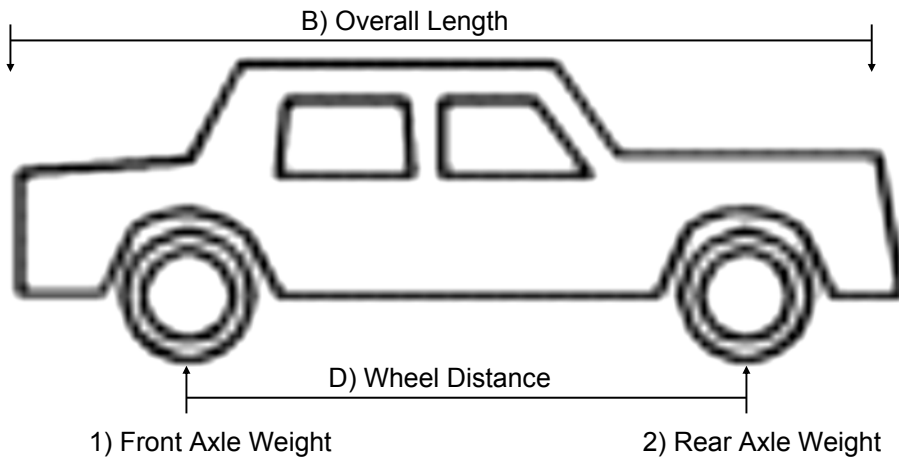

BOOTH NUMBER: _____
 COMPANY NAME: _____

Vehicle Description	A) Overall Width	B) Overall Length	Total Sq. Ft.	C) Wheel Distance	D) Wheel Distance	1) Front Axle Wgt.	2) Rear Axle Wgt.	Total Weight	Total Price	
									\$	
									\$	
									\$	
									\$	
* For dual axle vehicles measure distance from the front wheel to between the back wheels								Total Due		\$



VALLEY
EXPO & DISPLAYS
 BETTER IDEAS. BETTER RESULTS.
 valleyexpodisplays.com



Register Here for Online Ordering...
 www.valleyexpodisplays.com
 EMAIL: EVENTS@VALLEYEXPDISPLAYS.COM
 FAX: 815.873.1544

**PORTABLE
 MODULAR
 DISPLAY RENTAL**

International Fuel Ethanol Workshop & Expo 2017
Minneapolis Convention Center, June 19 - 21, 2017

ADVANCE PRICE DEADLINE:
 May 26, 2017

Orders with payment in full must be received by May 26, 2017, for Advance Prices. All orders subject to availability of equipment. Prices include delivery to booth, set up and removal. All equipment remains property of Valley Expo & Displays. No orders will be accepted without payment in full. **Orders refused after delivery to booth will be subject to a 100% service charge.**
Thank you for your order!

Graphics: Headers do not include graphics. Headers can be one color or full four color digital process. There are several graphic options. Headers, Small panels, Backlit panels, Full length panels. Design is available and all proofing can be done via Email. Call (877) 332-4292 for all services available.

Item #	Description	Hardware Advance Rental Price*	Hardware Regular Rental Price*	Hardware Sale Price*	Qty	Total
115	Capsule Counter	\$398.00	\$517.00	\$1,592.00		
129	Fan Counter	\$701.00	\$911.00	\$2,804.00		
135	Rectangle Counter	\$462.00	\$600.00	\$1,848.00		
137	Rectangle Counter w/Display	\$550.00	\$715.00	\$2,200.00		
138	Full View Display Counter	\$650.00	\$845.00	\$2,600.00		
139	Pedestal	\$360.00	\$468.00	\$1,440.00		
LIT	Literature Rack	\$115.00	\$173.00	\$460.00		
IPAD	iPad Stand	\$175.00	\$228.00	\$700.00		
1160	Inline Table Top Pop-Up	\$625.00	\$783.00	\$2,200.00		
1000	Inline Floor Standing Pop-Up	\$1,073.00	\$1,365.00	\$3,992.00		
1001	Inline Floor Standing Pop-Up w/Counter	\$1,359.00	\$1,737.00	\$5,136.00		
2184	Inline 20 Ft Fabric Display	\$4,832.00	\$6,222.00	\$18,728.00		
2192	Inline 20 Ft Serpentine Pop-Up Display	\$1,807.00	\$2,289.00	\$6,628.00		
2193	Inline 20 Ft Hybrid Display	\$3,883.00	\$4,988.00	\$14,932.00		
4087	Island 20 Ft x 20 Ft Display	\$6947.00	\$9032.00	\$27,792.00		
4541	Island 20 Ft x 20 Ft Display	\$7,734.00	\$10,055.00	\$30,938.00		
4744	Island 20 Ft x 20 Ft Display	\$6,520.00	\$8,475.00	\$26,078.00		

*Graphics, taxes and shipping are not included.

Rental Units Include:

Material handling, installation & dismantle of exhibit.

1-150 watt Arm Light/Table Top Unit

2-150 watt Arm Light/Floor Unit

(Electrical Service and Labor to Install Lights is Not Included)

Total Items Ordered: _____
 Add 7.25% Sales Tax: _____
 Total Due This Page: \$ _____

Item # 1160, 1000, 1001, 2184, 2192, 2193, 4087, 4541, and 4744 includes a Standard Carpet (circle color)

Blue Red Grey Green Burgundy Black

Item # 1160 includes draped table (circle color) Blue White Gold Green Black Burgundy Red Teal Silver Purple

BOOTH NUMBER: _____

COMPANY NAME: _____





International Fuel Ethanol Workshop & Expo 2017

Minneapolis Convention Center, June 19 - 21, 2017

Counter Kit 115 Capsule counter \$398.00

- Freestanding counter constructed of lower Velcro compatible black fabric panels, black laminate top and locking storage.
- Dimensions approximately: 38.11"wide x 20"deep x 40"high
- All Rentals include: Material handling, installation and dismantle of exhibit only.
- Optional front graphic 20"wide x 30"high. Additional cost \$90.00

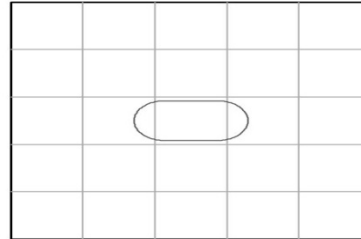

Counter Kit 129 Fan counter \$701.00

- Freestanding counter constructed of aluminum extrusion gray base panels and black laminate top with locking storage.
- Overall dimensions approximately: 64.75"wide x 33.407"deep x 40" high
- All Rentals include: Material handling, installation and dismantle of exhibit only.
- Optional front graphic 60.75"wide x 36.25"high. Additional cost \$379.00

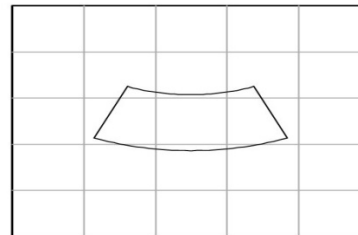

Counter Kit 135 Rectangle counter \$462.00

- Freestanding counter constructed of aluminum extrusion gray base panels and black laminate top and locking storage.
- Dimensions: 48"wide x 24" deep x 40"high
- All Rentals include: Material handling, installation and dismantle of exhibit only.
- Optional front graphic 38.25"wide x 32.25"high. Additional cost \$212.00

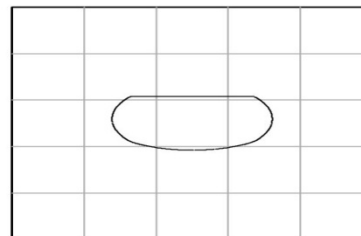



International Fuel Ethanol Workshop & Expo 2017

Minneapolis Convention Center, June 19 - 21, 2017

Counter Kit 137 Rectangle counter with display case top \$550.00

- Freestanding counter constructed of aluminum extrusion gray base panels and a clear plex top section and locking storage.
- Dimensions: 38.25"wide x 18.875"deep x 40"high
- All Rentals include: Material handling, installation and dismantle of exhibit only.
- Optional front graphic 38.25"wide x 25.75"high. Additional cost \$169.00

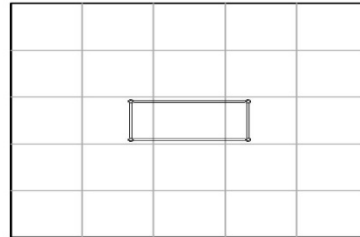

Counter Kit 138 Full View display case \$650.00

- Freestanding case has plex top, front, sides with two interior plexi shelves, lights and locks.
- Dimensions approximately: 72"wide x 24"deep x 40"high
- All Rentals include: Material handling, installation and dismantle of exhibit only.

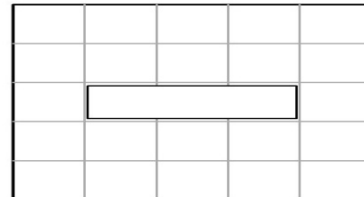

Pedestal Kit 139 \$360.00

- Freestanding counter constructed of white laminate base, black laminate top and locking storage.
- Dimensions approximately: 30"wide x 36"deep x 40"high
- All Rentals include: Material handling, installation and dismantle of exhibit only.

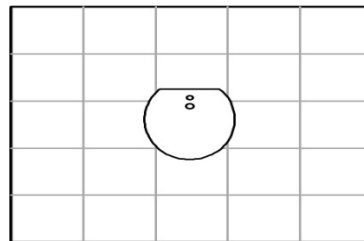



International Fuel Ethanol Workshop & Expo 2017

Minneapolis Convention Center, June 19 - 21, 2017

Literature Rack \$115.00

- Freestanding silver finish accordion style literature rack with 6 pockets 12 1/8" x 9" x 1" each.
- Dimensions approximately: 11"wide x 15"deep x 60"high
- All Rentals include: Material handling, installation and dismantle of exhibit only.

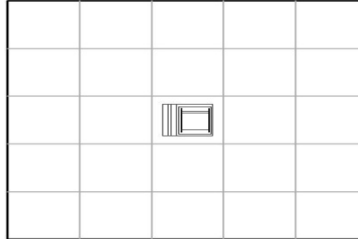

iPad Stand \$175.00

- Freestanding silver finish iPad stand with lock and power cord access. iPad NOT included.
- Dimensions approximately: 15.3"wide x 15.5"deep x 54.3"high
- All Rentals include: Material handling, installation and dismantle of exhibit only.

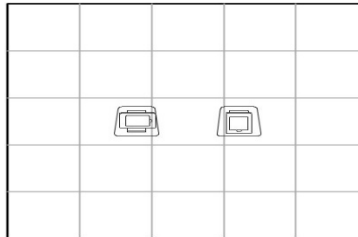

Inline Kit 1160 Table Top Pop-up Display \$525.00

- Classic expandable frame covered with black (Velcro compatible) fabric panels, one halogen stem light and one 6ft skirted table included.
- Dimensions approximately: 60" x 60"
- Standard table skirt color selection
- Standard carpet color selection
- All Rentals include: Material handling, installation and dismantle of exhibit only.
- NOT Included: Electronic/audio visual equipment, padding/visqueen, electrical service and electrical labor to install lights. Graphics sold separately. Call for quote.

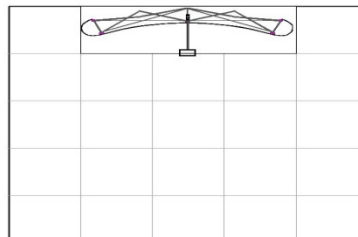



International Fuel Ethanol Workshop & Expo 2017

Minneapolis Convention Center, June 19 - 21, 2017

Inline Kit 1000 Floor Standing Pop-up Display \$973.00

- Classic expandable frame covered with (Velcro compatible) black fabric panels, two halogen stem lights.
- Dimensions approximately: 10ft wide x 8ft high
- Standard carpet color selection
- All Rentals include: Material handling, installation and dismantle of exhibit only.
- NOT Included: Electronic/audio visual equipment, padding/visqueen, electrical service and electrical labor to install lights. Graphics sold separately. Call for quote.

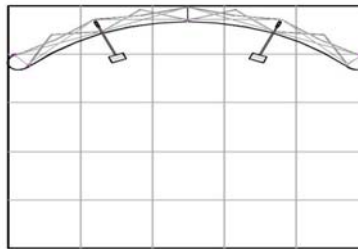
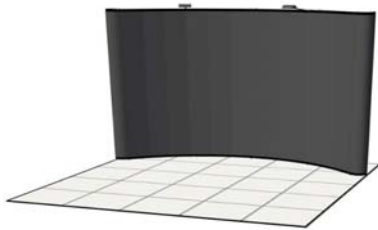

Inline Kit 1001 Floor Standing Pop-up Display \$1,259.00

- Classic expandable frame covered with (Velcro compatible) black fabric panels, two halogen stem lights. Includes counter.
- Dimensions approximately: 10ft wide x 8ft high
- Standard carpet color selection
- All Rentals include: Material handling, installation and dismantle of exhibit only.
- NOT Included: Electronic/audio visual equipment, padding/visqueen, electrical service and electrical labor to install lights. Graphics sold separately. Call for quote.

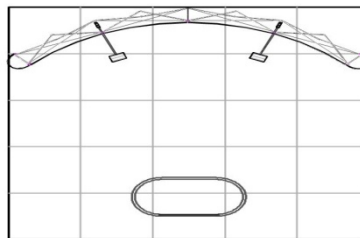
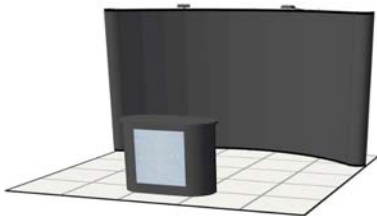



International Fuel Ethanol Workshop & Expo 2017

Minneapolis Convention Center, June 19 - 21, 2017

Inline Kit 2184 20ft Valley Fabric Display \$4,632.00

- Brushed aluminum extrusion with a rigid two piece center graphic, two side fabric graphics, three black canopies with lighting and black side wings. Includes counter kit 129.
- Dimensions approximately: 20ft wide x 8ft high
- Standard carpet color selection
- All Rentals include: Material handling, installation and dismantle of exhibit only.
- NOT Included: Electronic/audio visual equipment, padding/visqueen, electrical service and electrical labor to install lights. Graphics sold separately. Graphic package as shows \$2,689.00

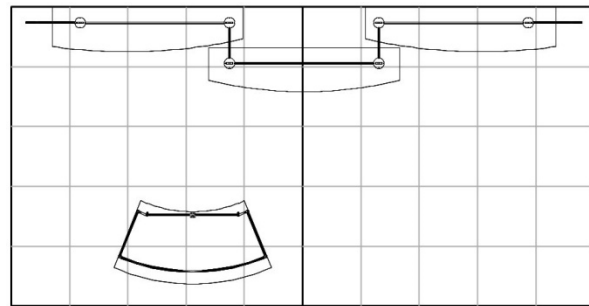

Inline Kit 2192 20ft Serpentine Pop-up Display \$1,607.00

- Classic expandable frame covered with (Velcro compatible) black fabric panels, set in a serpentine configuration with four halogen stem lights. Includes counter kit 115.
- Dimensions approximately: 20ft wide x 8ft high
- Standard carpet color selection
- All Rentals include: Material handling, installation and dismantle of exhibit only.
- NOT Included: Electronic/audio visual equipment, padding/visqueen, electrical service and electrical labor to install lights.
- Graphics sold separately. Call for quote.

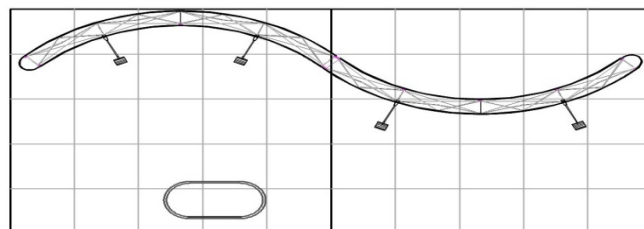



International Fuel Ethanol Workshop & Expo 2017

Minneapolis Convention Center, June 19 - 21, 2017

Inline Kit 2193 20ft Hybrid Display \$3,683.00

- Expandable frame covered with black (Velcro compatible) fabric panels, two halogen stem lights in the center flanked by aluminum structure and rigid infill panels. Includes counter kit 135.
- Dimensions approximately: 20ft wide x 8ft high
- Standard carpet color selection
- All Rentals include: Material handling, installation and dismantle of exhibit only.
- NOT Included: Electronic/audio visual equipment, padding/visqueen, electrical service and electrical labor to install lights. Graphics sold separately. Graphic package as shows \$5,641.00

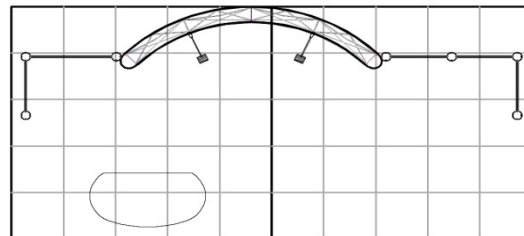

Island Kit 4087 20ft x 20ft Island Display \$6,617.00 (Innovative Control Solutions)

- Brushed aluminum extrusion creating a center tower and two side panels with gray infill panels. Includes six stem lights, one counter kit 129, one standard 36" x 30" café table and four standard side chairs.
- Dimensions approximately: 20ft x 20ft x 12ft or 16ft high
- Standard carpet color selection
- All Rentals include: Material handling, installation and dismantle of exhibit only.
- NOT Included: Electronic/audio visual equipment, padding/visqueen, electrical service and electrical labor to install lights.
- Graphics sold separately. Graphic package as shows \$4,627.

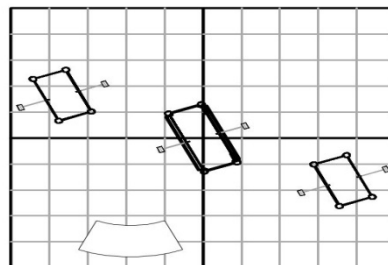



International Fuel Ethanol Workshop & Expo 2017

Minneapolis Convention Center, June 19 - 21, 2017

Island Kit 4541 20ft x 20ft Island Display \$7,366.00

- Brushed aluminum extrusion creating a corner storage closet, with four stem lights. A aluminum curved header, four workstations gray base panels, black laminate top with monitor mounting brackets and storage. One counter kit 129.
- Dimensions approximately: 20ft x 20ft x 12ft or 16ft high
- Standard carpet color selection
- All Rentals include: Material handling, installation and dismantle of exhibit only.
- NOT Included: Electronic/audio visual equipment, padding/visqueen, electrical service and electrical labor to install lights. Graphics sold separately. Graphic package as shows \$5,958.00

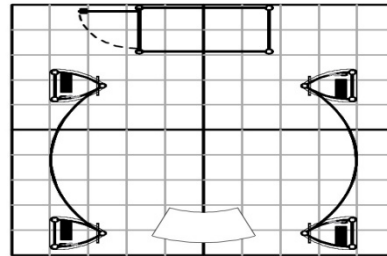

Island Kit 4744 20ft x 20ft Island Display \$6,209.00

- Brushed aluminum extrusion creating a round center tower. Two curved side wings with one workstation, gray base panels, black laminated top, on each end with storage. Includes four stem lights and one counter kit 129,
- Dimensions approximately: 20ft x 20ft x 12ft or 16ft high
- Standard carpet color selection
- All Rentals include: Material handling, installation and dismantle of exhibit only.
- NOT Included: Electronic/audio visual equipment, padding/visqueen, electrical service and electrical labor to install lights. Graphics sold separately. Graphic package as shows \$7,279.00

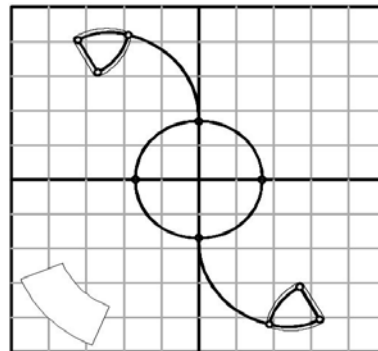



Register Here for Online Ordering...
www.valleyexpodisplays.com
 EMAIL: EVENTS@VALLEYEXPDISPLAYS.COM
 FAX: 815.873.1544

EVENT LABOR

International Fuel Ethanol Workshop & Expo 2017

Minneapolis Convention Center, June 19 - 21, 2017

ADVANCED PRICE DEADLINE:
May 26, 2017

Display Installation: To ensure prompt and efficient processing of your labor request for installation and dismantling of displays, please review the information on this page carefully, and contact us if you have any questions.

All installation and dismantling will be performed by qualified personnel in compliance with any applicable labor contracts. If you wish to hire Valley Expo & Displays to perform this work, please complete this form, and return it with payment to Valley Expo. **Orders with payment in full must be received by May 26, 2017, for Advance Prices.** All floor orders subject to availability of labor at the show site.

A minimum charge of one hour per man will apply to all labor orders, with the time commencing upon assignment of labor in accordance with your order. **IT IS IMPORTANT, THEREFORE, THAT YOU CHECK IN AT THE VALLEY EXPO & DISPLAYS SERVICE DESK TO PICK UP THE LABOR YOU HAVE ORDERED, AND TO RETURN THOSE PEOPLE TO THE SERVICE DESK UPON COMPLETION. IF YOU FAIL TO PICK UP LABOR YOU HAVE ORDERED, A ONE HOUR PER MAN NO-SHOW CHARGE WILL APPLY.**

Surcharge: All work performed during move in times of 8am-5pm on Sunday, June 18th and 8am-noon Monday, June 19th will be done at the hourly rate below. All work performed outside of these times will be subject to a 20% Surcharge.

Supervision: If Valley Expo personnel are to perform work without your supervision, please forward all necessary instructions, drawings or diagrams in advance with this order. We add a 25% supervision fee.

Requested Starting Time can only be guaranteed at the start of the working day (8:00AM), or the official beginning of set up, if later in the day. We will make every attempt to provide labor at times subsequent to 8:00 AM (or start of official set up), however such starting time must be approximate since labor is assigned to jobs at the start of the day, and it is impossible to gauge completion times of the first job assignments.

Authorization to Provide Labor Services: By completing the Event Labor Form, it is understood that Valley Expo & Displays and its subcontractors do not automatically insure materials, that insurance, if any, shall be arranged by the Exhibitor and the amounts payable to Valley Expo & Displays for labor services are based on the value of the services rendered and the scope of Valley Expo & Displays' liability as herein set forth. The amounts payable to Valley Expo & Displays are unrelated to the value of the Exhibitor's property being handled by Valley Expo & Displays or its subcontractors. It is impractical and extremely difficult to fix the value of each item handled by Valley Expo & Displays or its subcontractors. It is agreed therefore that if Valley Expo & Displays or its subcontractors should be found liable for loss or damage to Exhibitor's materials, the liability shall be limited to the specific article that was physically lost or damaged. Such liability shall be limited to a sum less than or equal to the charges for services rendered as agreed upon damages bit as a penalty, and such agreed upon damages shall be the Exhibitors exclusive remedy.

Installation & Dismantling	Straight Time Rate
Advance	\$ 142.65
Floor	\$ 185.45
Supervision Installation & Dismantling	
Advance	\$ 142.65
Floor	\$ 185.45

Computation of Labor Charges	# of Workers x	# Hours x	Labor Rate	Total
Installation				
Dismantling				
Total Due				\$

Requesting Date & Time	Date Labor Requested	Time Labor Requested
Installation		AM or PM
Dismantling		AM or PM

Requested starting times cannot be guaranteed, however, every effort is made to meet all requests.

Please provide brief description of labor requested:

BOOTH NUMBER:

COMPANY NAME:





Register Here for Online Ordering...
www.valleyexpodisplays.com
EMAIL: EVENTS@VALLEYEXPDISPLAYS.COM
FAX: 815.873.1544

**SUPERVISED LABOR
INSTALLATION &
DISMANTLE**

**International Fuel Ethanol Workshop & Expo 2017
Minneapolis Convention Center, June 19 - 21, 2017**

**PLEASE COMPLETE THE FOLLOWING INFORMATION ONLY IF VALLEY IS SETTING UP
AND/OR DISMANTLING YOUR DISPLAY . THIS INFORMATION WILL HELP US BETTER SERVE YOU.**

Company _____ Booth No _____

Contact Person _____ Phone _____

Freight will be shipped to Warehouse _____ Show Site _____ Date Shipped _____

Total # of Crates _____ Cartons _____ Fiber Cases _____ Special Handling _____

Setup Plans/Photo: Attached _____ To be sent with Exhibit _____ In Crate No. _____

Carpet: With Exhibit _____ Rented From Valley _____ Color _____ Size _____

Electrical Placement: _____ Please attach diagram with placement

Graphic: With Exhibit _____ Shipped Separately _____

Comments _____

Special Tools/Hardware Required _____

OUTBOUND SHIPPING INFORMATION

SHIP TO _____

METHOD OF SHIPMENT

COMMON CARRIER(NAME) _____ UPS _____ FED EX _____

SHOW CARRIER _____

IF LABELS ARE PROVIDED WHERE WILL THEY BE _____

FREIGHT CHARGES: Prepaid _____ Collect _____

Bill to _____

**In the event a selected carrier fails to show on the final move out time and day, Valley
will force shipment accordingly via show carrier**

BOOTH NUMBER: _____

COMPANY NAME: _____





Register Here for Online Ordering...
 www.valleyexpodisplays.com
 EMAIL: EVENTS@VALLEYEXPODISPLAYS.COM
 FAX: 815.873.1544

FORKLIFT SERVICE

International Fuel Ethanol Workshop & Expo 2017
Minneapolis Convention Center, June 19 - 21, 2017

ADVANCED PRICE DEADLINE:
 May 26, 2017

PLEASE COMPLETE THIS FORM FOR ALL IN-BOOTH FORKLIFT AND LABOR NEEDED. TO DETERMINE IF YOU NEED IN-BOOTH FORKLIFT AND LABOR, PLEASE READ THIS FORM CAREFULLY.

- In-Booth Forklift and Labor may be required to assemble displays or when uncrating, positioning, and reskidding equipment and machinery.
- A forklift is required for moving equipment and materials weighing 200 pounds or more.
- If you require a forklift, a crew will be assigned consisting of a Rigger Foreman and forklift with an operator.

IMPORTANT INFORMATION AND RATES

All exhibitors requesting labor must go to the Valley Service Desk to confirm labor requests. All labor and equipment requests should be confirmed by 2:00 pm the day prior, with the exception of the first day of move in. Requested starting times cannot be guaranteed, however, every effort is made to meet all requests. Valley reserves the right to dispatch all labor calls based upon availability of labor crews and the order that the requests are confirmed. Upon completion of work, an exhibitor representative must return to the Valley Service Desk to sign the completed work ticket and confirm accuracy of the work order. No adjustments will be made after the fact. Equipment and labor cancelled without a 24 hour notice will be charged a one (1) hour cancellation fee per worker and equipment ordered. If the labor and equipment is not used at the time confirmed there will be a one (1) hour no-show fee charged per work and equipment ordered.

The minimum charge for labor and equipment is one (1) hour per worker and forklift. Equipment and labor thereafter is charged in half (1/2) hour increments. **GRATUITIES IN ANY FORM, INCLUDING CASH, GIFTS OR LABOR HOURS FOR WORK NOT ACTUALLY PERFORMED ARE PROHIBITED BY VALLEY.** Valley requires the highest standards of integrity from all employees. Please call us to report fraudulent or unethical behavior. All rates are subject to change if necessitated by increased labor and material costs. **SURCHARGES:** All work performed during move in times of 8am-5pm on Sunday, June 18 and 8am-noon Monday, June 19 will be done at the hourly rate listed below. All work performed outside of these times will be subject to a 20% surcharge.

ADVANCE LABOR RATES AS FOLLOWS IF ORDERED BY ABOVE DEADLINE DATE: **FORKLIFT CREW**
 Rate \$358.85 per hour

ONSITE LABOR RATES AS FOLLOWS IF ORDERED AFTER ABOVE DEADLINE DATE:
 Rate \$466.55 per hour

BOOTH NUMBER: _____

COMPANY NAME: _____

PLEASE INDICATE SERVICE

PLACE ORDER HERE

Valley is responsible for the Following:

- Uncrating
- Leveling
- Reskidding
- Unskidding
- Dismantling
- Positioning
- Recrating

SCHEDULE DATE(S)	SCHEDULE START TIME	SCHEDULE END TIME	TOTAL # OF HOURS	TOTAL # OF FORKLIFTS	LABOR RATE	TOTAL
------------------	---------------------	-------------------	------------------	----------------------	------------	-------

						\$
						\$
						\$
						\$

I agree in placing this order that I have accepted Valley Payment Policy and Valley Terms & Conditions of Contract.

1. Total Labor Ordered	\$
2. Total Due	\$

Please estimate the number of forklifts and/or workers and hours per forklift and/or worker needed for installation and dismantling above. If you do not require a forklift, order the number of laborers required on the Event Labor Form. Invoice will be calculated according to actual hours worked.





Register Here for Online Ordering...
www.valleyexpodisplays.com
 EMAIL: EVENTS@VALLEYEXPODISPLAYS.COM
 FAX: 815.873.1544

**HANGING
SIGN**

International Fuel Ethanol Workshop & Expo 2017
Minneapolis Convention Center, June 19 - 21, 2017

BOOTH NUMBER:

COMPANY NAME:

SIGN DESCRIPTION, SIZE & WEIGHT

- For signs other than banners, include blueprint or drawing with detailed information so hanging anchor points can be determined.

Type: Cloth Banner _____
 Metal or Wood _____
 Other _____

Shape: Square _____
 Triangle _____
 Rectangle _____
 Other _____

Size: Height _____
 Length _____
 Width _____
 Weight of Sign _____

Does Your Sign Require:
 Electricity _____
 Assembly _____

PLACEMENT DIAGRAM

- Use diagram below to represent your booth space. Indicate how far in from each boundary you would like your sign placed.
- The ceiling structure and relation to the support beams may require your sign to be moved from your specified location.

_____ Feet in from the back Aisle # _____

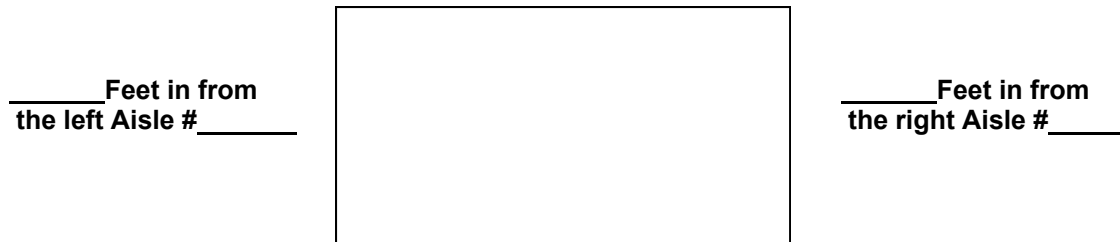

_____ Feet in from the front Aisle # _____

Number of feet from floor to top of sign: _____



RUSH!

HANGING SIGN

FROM:

HANGING SIGN

TO:

EXHIBITING COMPANY

International Fuel Ethanol Workshop & Expo 2017

SHOW NAME

BOOTH NUMBER

C/O VALLEY EXPO & DISPLAYS
YRC TRANSPORTATION
12400 DUPONT AVENUE SOUTH
BURNSVILLE, MN 55337

Shipment MUST Arrive by:
Monday, June 5, 2017

CERTIFIED WEIGHT TICKETS ARE REQUIRED FOR ALL SHIPMENTS. Drivers must check in by 2:00 pm to be guaranteed same day unloading. Warehouse receiving hours are MON-FRI, 9:00am - 3:00pm.

Carrier _____
Number _____ of _____ pieces

RUSH!

HANGING SIGN

FROM:

HANGING SIGN

TO:

EXHIBITING COMPANY

International Fuel Ethanol Workshop & Expo 2017

SHOW NAME

BOOTH NUMBER

C/O VALLEY EXPO & DISPLAYS
YRC TRANSPORTATION
12400 DUPONT AVENUE SOUTH
BURNSVILLE, MN 55337

Shipment MUST Arrive by:
Monday, June 5, 2017

CERTIFIED WEIGHT TICKETS ARE REQUIRED FOR ALL SHIPMENTS. Drivers must check in by 2:00 pm to be guaranteed same day unloading. Warehouse receiving hours are MON-FRI, 9:00am - 3:00pm.

Carrier _____
Number _____ of _____ pieces

VALLEY
EXPO & DISPLAYS
 BETTER IDEAS. BETTER RESULTS.
 valleyexpodisplays.com



Register Here for Online Ordering...
www.valleyexpodisplays.com
 EMAIL: EVENTS@VALLEYEXPDISPLAYS.COM
 FAX: 815.873.1544

**SIGN &
 BANNER**

International Fuel Ethanol Workshop & Expo 2017
Minneapolis Convention Center, June 19 - 21, 2017

ADVANCED PRICE DEADLINE:
 May 26, 2017

This form can be used to order custom show cards and banners for your exhibit booth. **Custom signs and banners can be ordered in advance only.** We must receive your order with payment by **May 26, 2017**, to guarantee delivery.

Labor to install signs or banners is not included. Please refer to the Display Installation Order Form for assistance in installing your signs if it will be needed.

All signs are printed on white background. 10 word limit per sign. Additional words and logos are extra. **Attach your sign copy to a separate page.** Please provide us with a contact name, E-mail address and phone number in case we have questions.

Contact for sign questions: _____

Foamcore Signs - White Background/One Color	Quantity	Price	Total
11" x 14"		\$ 59.45	
14" x 22"		\$ 83.35	
22" x 28"		\$ 105.50	
28" x 44"		\$ 143.85	

Foamcore Signs - White Background/Two Color	Quantity	Price	Total
22" x 28"		\$ 135.10	
28" x 44"		\$ 174.65	

Vinyl Banners - White Background Only	Quantity	Price	Total
2' x 4'		\$ 145.05	
2' x 6'		\$ 174.30	
2' x 8'		\$ 262.00	

Grommets for handing are included

Miscellaneous	Quantity	Price	Total
Easel Back		\$ 11.35	
Logos		Call for Price	
Sign Grommets		\$ 4.15	
Color Background		Add 25%	
		Subtotal	
		7.25% Sales Tax	
		Total	

Sign copy to be arranged: Horizontally Vertically

Color of Printing (one color only): _____

Our sign shop can produce any type of sign or banner you need, including multiple colors, photographic reproductions, etc. If an option or feature you want is not listed on this form, please call us for a special quote.

BOOTH NUMBER: _____

COMPANY NAME: _____



VALLEY
EXPO & DISPLAYS
 BETTER IDEAS. BETTER RESULTS.
valleyexpodisplays.com



Register Here for Online Ordering...
www.valleyexpodisplays.com
 EMAIL: EVENTS@VALLEYEXPODISPLAYS.COM
 FAX: 815.873.1544

**SHOW SITE
 WORK RULES**

International Fuel Ethanol Workshop & Expo 2017

Minneapolis Convention Center, June 19 - 21, 2017

Minneapolis, MN

To assist you in planning your participation in your Minneapolis show, we are certain you will appreciate knowing in advance that union labor will be required for certain aspects of your exhibit handling.

The following guidelines will help you in preparing your exhibit to conform to union jurisdiction.

GENERAL INFORMATION

All exhibiting company representatives are allowed to unload, install and dismantle the exhibits of that exhibiting company. Exhibitors must first check in with the Traffic Director. Exhibitors will then be directed to an area.

All Commercial vehicles (van lines, common carriers, air freight and display houses) must be handled by Valley Expo & Displays.

Exhibitors are allowed to unload and reload their own vehicles, but may not use motorized equipment, i.e., forklifts.

Valley Expo & Displays will not loan out any equipment to those loading and unloading their own equipment.

The transporting of equipment, exhibit materials, two-wheelers, etc., during move-in and move-out through glass doors is prohibited.

UNION PERSONNEL

Union personnel are available through Valley Expo & Displays for erection and dismantling of your exhibit. You, the exhibitor, are allowed to install and dismantle your booth provided you use your own bona fide company employees. Outside storefront labor is not allowed. If you choose to hire labor, you must obtain union personnel through Valley Expo & Displays, the official contractor.

If you choose to use an exhibitor appointed contractor, please refer to the E.A.C. section of this service kit.

FIRE AND SAFETY

- All table coverings and display materials must be fire resistant. All displays and exhibits are subject to inspection by the Minneapolis Fire Department.
- Storage of empty container in the Exhibit Hall is absolutely prohibited. Arrangements must be made with Valley Expo & Displays to store empty crates.
- Written authorization is required by Show Management and the Minneapolis Fire Department for any electrical, mechanical or chemical devices which may be deemed hazardous by the Minneapolis Fire Department.

GRATUITIES

Our Work Rules prohibit the SOLICITATION of tips by any of our employees. Our employees are paid excellent wages denoting a professional status and we feel that tipping is not necessary. Should you be SOLICITED for a tip, please report the incident to our Exhibitor Services Center as soon as possible.

BOOTH NUMBER:

COMPANY NAME:

BOOTH





FLORAL ORDER FORM

Name of Show:			
Location:		Show Dates:	
Exhibitor:		Booth Number:	
Bill to:		Email:	
Address:		City:	State: Zip:
Phone:	Fax:	Company Representative:	
Purchase Order #:	Job #:	Date Ordered:	
COMPLETE THIS BOX ONLY IF DESIGNER IS NEEDED ON SITE			
Booth Contact: _____		Contact Phone: _____	Available Time/Date: _____

PAYMENT INFORMATION

Circle one VISA MC AMEX DISCOVER

Name: _____

Card #: _____

Exp. Date: _____ CVV code: _____

Signature: _____

- Foliage plants and architectural containers on rental basis.
- Price includes: ***PLANT INSTALLATION, ARCHITECTURAL CONTAINERS, SERVICING THROUGHOUT THE SHOW, & DISMANTLING AT END OF SHOW***
- **NO ADJUSTMENTS NOR REFUNDS CAN BE MADE AFTER THE SHOW OPENING.**

Quantity	Tropical Plants <i>(Please specify quantity, heights, and variety)</i>	Price	Total
	Potted Ferns	\$66.40	
	2' Plants	\$97.50	
	3' Plants	\$101.05	
	4' Plants	\$116.50	
	5' Plants	\$151.55	
	6'-7' Plants	\$170.00	
	Containers for Plants: Black _____ White _____		
	<i>TALLER PLANTS ARE AVAILABLE, PLEASE INQUIRE IN ADVANCE</i>		
	Blooming Plants		
	Potted Mums <i>(Yellow, White, & Lavender)</i>	\$73.05	
	Potted Azaleas <i>(Red, Pink, & White)</i>	\$73.05	
	Bromeliads	\$73.05	
	Floral Arrangements Please Choose Tropical or Seasonal <i>(Please indicate desired colors)</i> <i>Floral Arrangements are only guaranteed for 3 days</i>		
	Small Arrangement <i>(12"x12")</i>	\$86.50	
	Medium Arrangement <i>(18"x14")</i>	\$110.00	
	Large Arrangement <i>(24"x18")</i>	\$132.50	
		Tax (8%)	
		TOTAL	

Floral Exhibits, Ltd.
1420 S Rockwell St.
Chicago, IL 60608

Phone #: 773.277.1888
Fax #: 773.277.1919
www.floralexhibits.com

PLEASE RETAIN A COPY FOR YOUR RECORDS



2017 AFR® TRADE SHOW FURNISHINGS KIT CATALOG

afir®
TRADE SHOW
FURNISHINGS

ELEVATE THE EXPERIENCE

WHISPER



Whisper Sofa

White Leather
87"L x 37"D x 35"H



Whisper Loveseat

White Leather
61"L x 37"D x 35"H



Whisper Chair

White Leather
35"L x 37"D x 35"H



Whisper Bench Ottoman

White Leather
60"L x 24"D x 17"H



Whisper Square Ottoman

White Leather
40"Square x 17"H



Whisper Round Ottoman

White Leather
46"Round x 17"H

FUNCTION



Function Armless Chair

White Leather
28"Square x 29"H



Function Corner

White Leather
28"Square x 29"H

CONTINENTAL



Continental Curved Loveseat

White Leather
 82"L x 34"D x 31"H



Continental Reverse Curved Loveseat

White Leather
 72"L x 34"D x 31"H



Continental Wedge Ottoman

White Leather
 30"L x 34"D x 19"H



Continental Curved Bench Ottoman

White Leather
 70"L x 26"D x 19"H



Continental Half Moon Ottoman

White Leather
 33"L x 19"D x 19"H

SOPHISTICATION



Sophistication Sofa

White Leather
 72"L x 31"D x 48"H



Sophistication Loveseat

White Leather
 48"L x 31"D x 48"H



Sophistication Chair

White Leather
 24"L x 31"D x 48"H

SOPHISTICATION



Sophistication Corner

White Leather
31"Square x 48"H



Sophistication Ottoman

White Leather
31"Square x 19"H

BOCA



Boca Corner

Black Leather
27"Square x 30"H



Boca Armless

Black Leather
22"L x 27"D x 30"H

METRO



Metro Sofa

Black Leather
85"L x 35"D x 35"H



Metro Loveseat

Black Leather
60"L x 35"D x 35"H



Metro Chair

Black Leather
35"Square x 35"H

METRO



Metro Square Ottoman

Black Leather
40"Square x 17"H



Metro Bench Ottoman

Black Leather
60"L x 24"D x 17"H

SUAVE MIDNIGHT



Suave Midnight Sofa

Midnight Suede
77"L x 36"D x 33"H



Suave Midnight Loveseat

Midnight Suede
54"L x 36"D x 33"H



Suave Midnight Chair

Midnight Suede
32"L x 36"D x 33"H

GRAMMERCY

*See page 9 & 10 for additional Grammercy product available



Grammercy Sofa

Charcoal Leather
82"L x 36"D x 36"H



Grammercy Loveseat

Charcoal Leather
57"L x 36"D x 36"H



Grammercy Chair

Charcoal Leather
28"L x 36"D x 36"H

PARMA



Parma Sofa

Brown Leather
79"L x 37"D x 36"H



Parma Loveseat

Brown Leather
56"L x 37"D x 36"H



Parma Chair

Brown Leather
33"L x 37"D x 38"H



Parma Bench Ottoman

Brown Leather
60"L x 24"D x 17"H

MONTANA MOCHA



Montana Mocha Sofa

Mocha Tan Fabric
79"L x 35"D x 34"H



Montana Mocha Loveseat

Mocha Tan Fabric
57"L x 35"D x 34"H



Montana Mocha Chair

Mocha Tan Fabric
35"Square x 34"H

CHANDLER



Chandler Sofa

Red Leather
76"L x 37"D x 35"H



Chandler Loveseat

Red Leather
53"L x 37"D x 35"H



Chandler Chair

Red Leather
31"L x 37"D x 35"H



Chandler Bench Ottoman

Red Leather
60"L x 24"D x 17"H

IMPERIAL



Imperial Sofa

Purple Microfiber
82"L x 36"D x 36"H



Imperial Chair

Purple Microfiber
28"L x 36"D x 36"H



Imperial Bench Ottoman

Purple Microfiber
48"L x 21"D x 18"H

TANGERINE



Tangerine Sofa

Orange Microfiber
 84"L x 36"D x 33"H



Tangerine Chair

Orange Microfiber
 40"L x 36"D x 33"H



Tangerine Bench Ottoman

Orange Microfiber
 62"L x 24"D x 18"H

EVOKE



Evoke Sofa

Coffee Resin Frame with Tan Cushions
 81"L x 35"D x 27"H



Evoke Chair

Coffee Resin Frame with Tan Cushions
 33"L x 35"D x 27"H



Evoke Cocktail Table

Coffee Resin Frame
 48"L x 24"D x 18"H



Evoke End Table

Coffee Resin Frame
 24"L x 28"D x 25"H



Evoke Cube

Coffee Resin Frame
 18"Square

STAGE CHAIRS



Midnight Stage Chair

Midnight Microfiber
 25"L x 26"D x 37"H



Chamois Stage Chair

Beige Microfiber
 25"L x 26"D x 37"H



Buckskin Stage Chair

Tan Microfiber
 25"L x 26"D x 37"H



Empire Chair

■ Black Leather
 □ White Leather
 28"L x 32"D x 32"H



Ibiza Chair

■ Black Leather
 □ White Leather
 31"L x 35"D x 32"H



Tulip Chair

Black Fabric/Tilt Back/Caster Feet
 27"L x 26"D x 35"H



Monarch Chair

Bright White Leather
 28"Square x 30"H

OTTOMANS & BENCHES



Curved Bench

Continental White Leather
70"L x 26"D x 19"H



Square Ottoman

Metro Black Leather
 Whisper White Leather
 Grammercy Charcoal Leather
 40"Square x 17"H



Bench Ottoman

Metro Black Leather
 Whisper White Leather
 Chandler Red Leather
 Grammercy Charcoal Leather
 Parma Brown Leather
 60"L x 24"D x 17"H



Hayden Bench

Black Wood
67"L x 16"D x 17"H



Essentials Storage Ottoman

White Leather with Locking Mechanism
48"L x 24"D x 20"H
Lock Not Included



Round Ottoman

Grammercy Charcoal Leather
 Whisper White Leather
 46"Round x 17"H



1/4 Round Ottoman

Grammercy Charcoal Leather
 Whisper White Leather
 34"L x 19"D x 17"H

BANQUETTES



Essentials Banquette

White Leather
 60"Round x 48"H (2 Pieces)



Whisper Banquette

White Leather
 59"Round x 38"H (2 Pieces)



Grammercy Banquette

Charcoal Leather
 59"Round x 38"H (2 Pieces)

TURNING BEDS



Essentials Turning Bed

White Leather
 96"L x 48"D x 34"H

CUBE OTTOMANS



Regency Cube Ottomans

From left to right: Orange Fabric, Teal Fabric, Ruby Fabric, Camel Fabric, Apple Fabric, Fuchsia Fabric
 18"Square

CUBE OTTOMANS



Cube Ottomans

From left to right: White Leather, Black Leather, Red Vinyl, Green Vinyl, Blue Vinyl, Purple Vinyl
18" Square

CHARGED



Essentials Turning Bed - Charged

White Leather
96"L x 48"D x 25"H

**White slip cover available for black charging unit.*



Boca Corner - Charged

Bright White Leather
27" Square x 30"H



Boca Chair - Charged

Bright White Leather
22"L x 27"D x 30"H



Aspen Pub Table - Charged

White / Brushed Steel
72"L x 26"D x 42"H



Aspen Cocktail Table - Charged

White / Brushed Steel
48"L x 24"D x 18"H



White Conference Table - Charged

White
96"L x 43"D x 30"H

OCCASIONAL TABLES



Tribeca Tables

End Table Wood/Black
 24"L x 28"D x 22"H
 Console Table Wood/Black
 48"L x 18"D x 30"H
 Cocktail Table Wood/Black
 48"L x 28"D x 19"H



Harmony Tables

End Table Wood/Esspresso
 24"Round x 22"H
 Console Table Wood/Esspresso
 52"L x 18"D x 30"H
 Cocktail Table Wood/Esspresso
 51"L x 28"D x 18"H

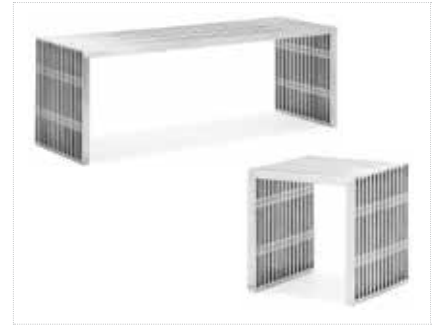

Novel Tables

End Table Satin Steel
 15"Square x 16"H
 Cocktail Table Satin Steel
 46"L x 15"D x 16"H



Aria Tables Red

End Table Red/Brushed Steel
 24"L x 20"D x 22"H
 Cocktail Table Red/Brushed Steel
 44"L x 20"D x 18"H



Aria Tables Green

End Table Green/Brushed Steel
 24"L x 20"D x 22"H
 Cocktail Table Green/Brushed Steel
 44"L x 20"D x 18"H



Aria Tables Blue

End Table Blue/Brushed Steel
 24"L x 20"D x 22"H
 Cocktail Table Blue/Brushed Steel
 44"L x 20"D x 18"H



Aria Tables Purple

End Table Purple/Brushed Steel
 24"L x 20"D x 22"H
 Cocktail Table Purple/Brushed Steel
 44"L x 20"D x 18"H



Aria Tables White

End Table White/Brushed Steel
 24"L x 20"D x 22"H
 Console Table White/Brushed Steel
 44"L x 20"D x 30"H
 Cocktail Table White/Brushed Steel
 44"L x 20"D x 18"H



Aria Tables Charcoal

End Table Storm Grey/Brushed Steel
 24"L x 20"D x 22"H
 Console Table Storm Grey/Brushed Steel
 44"L x 20"D x 30"H
 Cocktail Table Storm Grey/Brushed Steel
 44"L x 20"D x 18"H

OCCASIONAL TABLES



Reno Tables

End Table Chrome
 25"Round x 21"H
 Console Table Chrome
 46"L x 17"D x 29"H
 Cocktail Table Chrome
 45"L x 32"D x 18"H



Vivid Tables

End Table Smoked Powder Coat Finish
 26"Square x 21"H
 Console Table Smoked Powder Coat Finish
 50"L x 24"D x 30"H
 Cocktail Table Smoked Powder Coat Finish
 50"L x 24"D x 16"H



Club Cocktail Table

44"L x 22"D x 18"H
 (Includes built in Wireless LED Lighting)



Club End Table

22"Square x 18"H
 (Includes built in Wireless LED Lighting)



Rose Table

17"Round x 17"H



Zanzibar Table

17"Square



Cube End Tables

■ Black 24"
 □ White 24"
 24"Square x 21"H



Cube Cocktail Tables

■ Black 30"
 □ White 30"
 30"Square x 16"H
 ■ Black 24"
 □ White 24"
 24"Square x 16"H



Hylton Tablet Table

White/Brushed Steel
 18"L x 12"D x 28"H

OCCASIONAL TABLES



Phoebe Tables

From left to right: Yellow, Lime Green, Rose, Gold, Teal
 17"Round x 22"H

BARS & BAR BACKS



Manhattan Bar

Black/Chrome
 63"L x 29"D x 42"H



VIP Glow Bar 6'

Frosted Plexi with Built-in Wireless LED Kit
 72"L x 24"D x 42"H(Bar)
 13"D x 18"H (Shelf)
 *Includes remote control



VIP Glow Bar 4'

Frosted Plexi with Built-in Wireless LED Kit
 48"L x 24"D x 42"H(Bar)
 13"D x 18"H (Shelf)
 *Includes remote control



Bar

■ Black with 2 shelves in back
 □ White with 2 shelves in back
 48"L x 16"D x 42"H



Blox Bar Back

Walnut/Brushed Metal
 30"L x 16"D x 86"H
 Please Inquire About Shelf Dimensions



Piazza Bar Back

■ Black
 □ White
 44"L x 12"D x 80"H
 13"W x 14.25"H (Inside Shelf)

BAR STOOLS



Vienna Stool

Gray Acrylic
 Orange Acrylic
 Teal Acrylic
 17"W x 17"D x 39"H



Criss Cross Bar Stool

Espresso Leather
 White Leather
 15"W x 19"D x 41"H



Escape Stool

Natural Maple
 16"Square x 41"H



Silk Back Bar Stool

Black
 White
 Blue
 Green
 Purple
 Red
 17"L x 18"D x 42"H



Euro Bar Stool

Black
 21"W x 23"D x 43"H



Hourglass Bar Stool

Black
 White
 18"W x 20"D x 43"H



Equino Stool

Black
 White
 15"W x 13"D x 35"H



Caprice Stool

Black Fabric
 25"W x 26"D x 44"H



Sonic Stool

Black
 22"W x 23"D x 42"H

BAR STOOLS



Marcus Bar Stool
18"W (at footbase) x 29"H



Regal Stool
Brown Leather
19"W x 24"D x 45"H

CAFE CHAIRS



Vienna Chair
 ■ Gray Acrylic
 ■ Orange Acrylic
 ■ Teal Acrylic
 21" Square x 32"H



Silk Back Chair
 ■ Black
 ■ White
 ■ Blue
 ■ Green
 ■ Purple
 ■ Red
 17"W x 18"D x 34"H
 (Also Available With Arms)



Escape Chair
Natural Maple
17"W x 16"D x 32"H



Leslie Chair
White
17"W x 21"D x 31"H



Criss Cross Chair
 ■ Espresso Leather
 ■ White Leather
 17"W x 21"D x 35"H



Sonic Chair
Black
20"W x 21"D x 32"H

CAFE CHAIRS



Elio Chair

17"Square x 33"H



Caprice Chair

Black
 25"W x 24"D x 32"H



Comet Chair

Black
 23"W x 22"D x 32"H (With Arms)
 19"W x 22"D x 32"H (Without Arms)



Trend Chair

■ Black
 □ White
 19"W x 18"D x 33"H



Regal Dining Chair

Brown Leather
 19"W x 23"D x 38"H

BAR TABLES



Euro Bar Table

Black/Black 30"
 30"Round x 42"H
 Black/Black 36"
 36"Round x 42"H



Silk Bar Table

Black/Chrome 30"
 30"Round x 42"H
 Black/Chrome 36"
 36"Round x 42"H



Park Ave Bar Table

Maple/Chrome 30"
 30"Round x 42"H
 Maple/Chrome 36"
 36"Round x 42"H



Chardonnay Bar Table

Clear Glass/Chrome
 31"Round x 42"H



Aspen Pub Table

White/Brushed Steel
 72"L x 26"D x 42"H



Blanco Round Bar Table

White/Chrome 30"
 30"Round x 42"H
 White/Chrome 36"
 36"Round x 42"H



Blanco Square Bar Table

White/Chrome
 24"Square x 42"H



Blanco Rectangle Bar Table

White/Chrome
 72"L x 24"D x 42"H



City Bar Table

Maple/Black 30"
 30"Round x 42"H
 Maple/Black 36"
 36"Round x 42"H

BAR TABLES



Summit Bar Table

White/Black 30"
 30"Round x 42"H
 White/Black 36"
 36"Round x 42"H



Spectrum Bar Table Red

Red/Chrome
 24"Square x 42"H



Spectrum Bar Table - Green

Green/Chrome
 24"Square x 42"H



Spectrum Bar Table Blue

Blue/Chrome
 24"Square x 42"H



Spectrum Bar Table Purple

Purple/Chrome
 24"Square x 42"H

CAFÉ TABLES



Euro Café Table

Black/Black 30"
 30"Round x 30"H
 Black/Black 36"
 36"Round x 30"H



Silk Café Table

Black/Chrome 30"
 30"Round x 30"H
 Black/Chrome 36"
 36"Round x 30"H



Park Ave Café Table

Maple/Chrome 30"
 30"Round x 30"H
 Maple/Chrome 36"
 36"Round x 30"H

CAFÉ TABLES



City Café Table

Maple/Black 30"
 30"Round x 30"H
 Maple/Black 36"
 36"Round x 30"H



Summit Café Table

White/Black 30"
 30"Round x 30"H
 White/Black 36"
 36"Round x 30"H



Blanco Café Table

White/Chrome 30"
 30"Round x 30"H
 White/Chrome 36"
 36"Round x 30"H



Blanco Café Table

White/Chrome Rectangle
 72"L x 24"D x 30"H

White/Chrome Square
 24"Square x 30"H



Spectrum Café Table Purple

Purple/Chrome
 24"Square x 30"H



Spectrum Café Table Red

Red/Chrome
 24"Square x 30"H



Spectrum Café Table Green

Green/Chrome
 24"Square x 30"H



Spectrum Café Table Blue

Blue/Chrome
 24"Square x 30"H



Aspen Dining Table

White/Brushed Steel
 72"L x 30"D x 30"H

OFFICE SEATING



Tamiri High Back Chair

Black Leather
25"W x 27"D x 45"H



Tamiri Mid Back Chair

Black Leather
25"W x 27"D x 41"H



Tamiri Guest Chair

Black Leather
25"W x 27"D x 37"H



Accord Chair

■ Black
□ White
25"Square x 44"H



Goal Task Chair

Black
25"Square x 39"H



Goal Task Chair Armless

Black
21"W x 24"D x 39"H

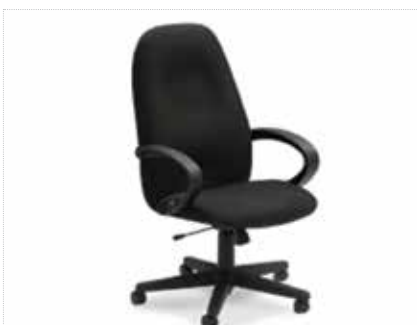

Enterprise High Back Conference Chair

Black Fabric
25"W x 27"D x 45"H



Enterprise Mid Back Conference Chair

Black Fabric
25"W x 27"D x 39"H



Enterprise Guest Chair

Black Fabric
25"W x 27"D x 37"H

OFFICE SEATING



Goal Drafting Stool

Black
25"W x 24"D x 48"H



Goal Drafting Stool Armless

Black
21"W x 24"D x 48"H

CONFERENCE TABLES



Conference Table Rectangle

- Black 6'
- Mahogany 6'
- Maple 6'
- White 6'

72"L x 36"D x 30"H

- Black 8'
- Mahogany 8'
- Maple 8'
- White 8'

96"L x 48"D x 30"H



Conference Table Racetrack

- Black 8'
- Mahogany 8'

96"L x 48"D x 30"H

- Black 6'
- Mahogany 6'

72"L x 36"D x 30"H



Conference Table Round

Mahogany
42"Round x 29"H

OFFICE FURNITURE



Computer Kiosk

Black
 White
 24" Square x 42"H



Computer Counter

Graphite
 48"L x 24"D x 42"H



Computer Desk

Graphite
 48"L x 24"D x 29"H



5 Shelf Bookcase

Black
 Mahogany
 36"L x 12"D x 72"H



Black Credenza

Black
 60"L x 20"D x 29"H



Black Double Pedestal

Black
 60"L x 30"D x 29"H



Credenza Maple

Maple
 72"L x 20"D x 29"H



Desk Maple

Double Pedestal
 60"L x 30"D x 29"H



Lateral File Maple

2 Drawer with Lock
 36"L x 20"D x 29"H

OFFICE FURNITURE



Genoa Storage Credenza

Mahogany 2 Filing Cabinets
 2-Drawers-Inside Shelves
 66"L x 20"D x 29"H



Genoa Kneespace Credenza

Mahogany 2 Filing Cabinets/2-Drawers
 66"L x 20"D x 29"H



Genoa Executive Desk

Mahogany Double Pedestal-Locking Drawers
 72"L x 36"D x 29"H



Presidential Kneespace Credenza

Mahogany
 24"L x 66"L x 29"H



Presidential Executive Desk

Mahogany
 36"L x 72"L x 29"H



Presidential File Cabinet

Mahogany
 24"L x 36"L x 29"H



Hayden Table

Black Wood
 78"L x 36"D x 30"H



Vivid Café Table Square

Clear Glass/Smoked Powder Coat Finish
 42"Square x 30"H



Vivid Café Table Rectangle

Clear Glass/Smoked Powder Coat Finish
 60"L x 36"D x 30"H

METAL FILE & STORAGE CABINETS



2-Drawer File

Black Letter
15"L x 25"D x 29"H
Black Legal
18"L x 25"D x 29"H



4-Drawer File

Black Letter
15"L x 25"D x 52"H
Black Legal
18"L x 25"D x 52"H



2-Drawer Lateral File

Black (Pictured)
36"L x 18"D x 27"H
Black (Not Pictured)
36"L x 20"D x 29"H



4-Drawer Lateral File

Black
36"L x 18"D x 54"H



Storage Cabinet

Black
36"W x 18"D x 72"H

PEDESTALS



Display Pedestals 42"

- Black
14"Square x 42"H
- Black
24"Square x 42"H
- Black
18"Square x 42"H
- White
14"Square x 42"H



Display Pedestals 36"

- Black
14"Square x 36"H
- Black
24"Square x 36"H
- White
14"Square x 36"H
- White
24"Square x 36"H



Display Pedestals 30"

- Black
14"Square x 30"H
- Black
24"Square x 30"H
- Black
18"Square x 30"H
- White
14"Square x 30"H



Locking Pedestal

- Black
- White
- 24"Square x 42"H

MISCELLANEOUS ITEMS



Stanchion

Chrome
41"H

Stanchion Rope

Red Velour
6'L



Literature Stand

■ Black
 ■ Aluminum
 14.75"W x 12"D x 53.5"H



Literature Rack

Black/Metal
 10.5"W x 9.5"D x 57"H



Refrigerator Compact

White 4 Cu Ft
 19"W x 21"D x 33.5"H



Plexi Display Unit

18" Square x 68"H
 (Height Includes Top Piece)



iPad[®] Stand

■ Black
 ■ Silver
 14.25"W x 41.75"H
 (Fits 2nd, 3rd, or 4th iPad[®] generations. Can be positioned in portrait or landscape views.)

**Apple[®] and iPad[®] are registered trademarks of Apple Inc.*

LIGHTING



Brushed Steel Lamps

Table Lamp White/Steel
26"H
Floor Lamp White/Steel
66"H



Brushed Nickel Lamps

Table Lamp White/Nickel
29"H
Floor Lamp White/Nickel
60"H



Rubbed Bronze Lamps

Table Lamp White/Bronze
28"H
Floor Lamp White/Bronze
60"H

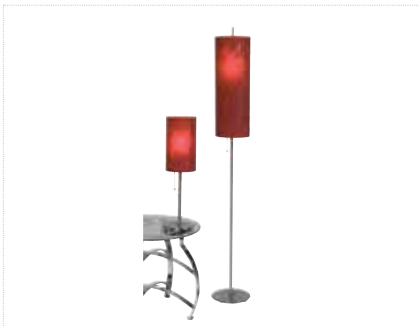

Brushed Steel Lamps

Table Lamp Red/Steel
26"H
Floor Lamp Red/Steel
66"H



Neutrino Floor Lamp

Steel
67"H

DESIGN YOUR BOOTH SPACE **YOUR WAY**



10x20 Booth Footprint

Grammercy Loveseat & Corner • Novel Cocktail & End Table • 4FT VIP Bar • Criss Cross Chairs • Café Table



10x10 Booth Footprint

Chamois Stage Chairs • Phoebe Table • Equino Stools
Chardonnay Bar Table



10x10 Booth Footprint

Metro Sofa & Chair • Novel End Tables
Equino Stools • Silk Bar Table



20x20 Booth Footprint

Whisper Sofa & Chairs • Reno Cocktail & End Tables • Criss Cross Stools • Blanco Bar Table



Trade Show Order Form

Diana Gonzalez / Janet Anderson

Dgonzalez@rentfurniture.com

Janderson@rentfurniture.com

Fax: 630-783-8561 Office: 630-796-7942

TRADE SHOW INFORMATION

Show Name		Company Name	
Show Dates		Contact Name	
Venue Name		Contact Cell #	
Venue Address		Delivery Date	Time:
City, State, Zip		Pickup Date	Time:
Booth # and Name		Show Contractor	Valley Expo

All Furniture Subject to Availability

Terms & Conditions:	<p>Payments: Payment terms - 100% Payment due prior to delivery to secure the order unless Credit Approved with AFR You may be subject to additional charges by the drayage company for moving the furniture from the loading dock to the exhibit space, please check your Exhibitor Manual.</p> <p>Cancellation Fee: If cancelled within 3 days prior to delivery, a 100% charge will be applied.</p> <p>Late Fee: All orders received within 14 days of the show opening will receive at 25% Late Fee. Show Site orders will be based on availability and charged a 30% Late Fee.</p> <p>Confirmation: Please email your sales team if you do not receive confirmation within 1-2days of submitting this order form.</p>
--------------------------------	--

Item Number	Weight	Description	Dimensions	Standard	Qty.	Total
Whisper (Pg. 2)						
18228-0607	115 lbs.	Whisper White Leather Sofa	87"L x 37"D x 35"H	\$600.00		\$ -
18167-0471	90 lbs.	Whisper White Leather Loveseat	61"L x 37"D x 35"H	\$575.00		\$ -
18284-0487	60 lbs.	Whisper White Leather Chair	35"L x 37"D x 35"H	\$470.00		\$ -
18024-0003	30 lbs.	Whisper White Leather Bench Ottoman	60"L x 24"D x 17"H	\$260.00		\$ -
18184-0034	55 lbs.	Whisper White Leather Square Ottoman	40" Square x 17"H	\$260.00		\$ -
18184-0038	70 lbs.	Whisper White Leather Round Ottoman	46" Round x 17"H	\$260.00		\$ -
Function (Pg. 2)						
18284-0554	40 lbs.	Function White Leather Armless Chair	28" Square x 29"H	\$315.00		\$ -
18066-0016	36 lbs.	Function White Leather Corner	28" Square x 29"H	\$340.00		\$ -
Continental (Pg. 3)						
18303-0001	105 lbs.	Continental White Leather Curved Loveseat	82"L x 34"D x 31"H	\$620.00		\$ -
18304-0001	105 lbs.	Continental White Leather Reverse Loveseat	72"L x 34"D x 31"H	\$600.00		\$ -
18296-0005	35 lbs.	Continental White Leather Wedge Ottoman	30"L x 34"D x 19"H	\$260.00		\$ -
18184-0131	75 lbs.	Continental White Leather Curved Bench	70"L x 26"D x 19"H	\$310.00		\$ -
18184-0132	30 lbs.	Continental White Leather Half Moon Ottoman	33"L x 19"D x 19"H	\$260.00		\$ -
Sophistication (Pg. 3 & 4)						
18228-0674	100 lbs.	Sophistication White Leather Sofa	72"L x 31"D x 48"H	\$620.00		\$ -
18167-0466	90 lbs.	Sophistication White Leather Loveseat	48"L x 31"D x 48"H	\$415.00		\$ -
18284-0563	60 lbs.	Sophistication White Leather Chair	27"L x 31"D x 48"H	\$310.00		\$ -
18066-0017	60 lbs.	Sophistication White Leather Corner	31" Square x 48"H	\$310.00		\$ -
18184-0130	40 lbs.	Sophistication White Leather Ottoman	31" Square x 19"H	\$235.00		\$ -
Boca (Pg. 4)						
18066-0026	38 lbs.	Boca Corner - Black	27"L x 27"D x 30"H	\$349.00		\$ -
18284-0786	28 lbs.	Boca Armless - Black	22"L x 27"D x 30"H	\$325.00		\$ -
Metro (Pg. 4 & 5)						
18228-0602	110 lbs.	Metro Black Leather Sofa	85"L x 35"D x 35"H	\$515.00		\$ -
18167-0467	90 lbs.	Metro Black Leather Loveseat	60"L x 35"D x 35"H	\$490.00		\$ -
18284-0482	75 lbs.	Metro Black Leather Chair	35" Square x 35"H	\$385.00		\$ -
18184-0179	30 lbs.	Metro Black Leather Square Ottoman	40" Square x 17"H	\$260.00		\$ -
18024-0008	50 lbs.	Metro Black Leather Bench Ottoman	60"L x 24"D x 17"H	\$260.00		\$ -
Suave Midnight (Pg. 5)						
18228-0085	105 lbs.	Suave Midnight Sofa	77"L x 36"D x 33"H	\$445.00		\$ -
18167-0069	80 lbs.	Suave Midnight Loveseat	54"L x 36"D x 33"H	\$390.00		\$ -
18284-0151	65 lbs.	Suave Midnight Chair	32"L x 36"D x 33"H	\$290.00		\$ -
Grammercy (Pg. 5)						
18228-0605	90 lbs.	Grammercy Charcoal Leather Sofa	82"L x 36"D x 36"H	\$575.00		\$ -
18167-0469	90 lbs.	Grammercy Charcoal Leather Loveseat	57"L x 36"D x 36"H	\$495.00		\$ -
18284-0485	40 lbs.	Grammercy Charcoal Leather Chair	28"L x 36"D x 36"H	\$315.00		\$ -
Parma (Pg. 6)						
18228-0789	100 lbs.	Parma Brown Leather Sofa	79"L x 37"D x 36"H	\$515.00		\$ -
18167-0577	90 lbs.	Parma Brown Leather Loveseat	56"L x 37"D x 36"H	\$490.00		\$ -
18284-0710	75 lbs.	Parma Brown Leather Chair	33"L x 37"D x 36"H	\$385.00		\$ -
18024-0061	30 lbs.	Parma Brown Leather Bench Ottoman	60"L x 24"D x 17"H	\$260.00		\$ -
Montana Mocha (Pg. 6)						
18228-0784	100 lbs.	Montana Mocha Sofa	79"L x 35"D x 34"H	\$480.00		\$ -
18167-0573	90 lbs.	Montana Mocha Loveseat	57"L x 35"D x 34"H	\$420.00		\$ -
18284-0704	75 lbs.	Montana Mocha Chair	35" Square x 34"H	\$325.00		\$ -
Chandler (Pg. 7)						
18228-0795	100 lbs.	Chandler Red Leather Sofa	76"L x 37"D x 35"H	\$515.00		\$ -
18167-0581	90 lbs.	Chandler Red Leather Loveseat	53"L x 37"D x 35"H	\$490.00		\$ -
18284-0717	75 lbs.	Chandler Red Leather Chair	31"L x 37"D x 35"H	\$385.00		\$ -
18024-0062	60 lbs.	Chandler Red Leather Bench Ottoman	60"L x 24"D x 17"H	\$260.00		\$ -
Imperial (Pg. 7)						
18228-0604	95 lbs.	Imperial Purple Sofa	82"L x 36"D x 36"H	\$445.00		\$ -
18284-0484	45 lbs.	Imperial Purple Chair	28"L x 36"D x 36"H	\$260.00		\$ -
18184-0134	45 lbs.	Imperial Purple Bench Ottoman	48"L x 21"D x 18"H	\$205.00		\$ -

Tangerine (Pg. 8)						
18228-0084	115 lbs.	Tangerine Orange Sofa	84"L x 36"D x 33"H	\$445.00	\$	-
18284-0150	60 lbs.	Tangerine Orange Chair	40"L x 36"D x 33"H	\$315.00	\$	-
18184-0032	45 lbs.	Tangerine Orange Bench Ottoman	62"L x 24"D x 18"H	\$205.00	\$	-
Evoke (Pg. 8)						
13229-0007	80 lbs.	Evoke Sofa	81"L x 35"D x 27"H	\$780.00	\$	-
13041-0015	40 lbs.	Evoke Chair	33"L x 35"D x 27"H	\$415.00	\$	-
13054-0011	20 lbs.	Evoke Cocktail Table	48"L x 24"D x 18"H	\$260.00	\$	-
13110-0009	20 lbs.	Evoke End Table	24"L x 28"D x 25"H	\$235.00	\$	-
13110-0008	10 lbs.	Evoke Cube	18" Square	\$160.00	\$	-
Stage Chairs (Pg. 9)						
18284-0478	29 lbs.	Midnight Microfiber Stage Chair	25"L x 26"D x 37"H	\$185.00	\$	-
18284-0477	29 lbs.	Chamois Microfiber Stage Chair	25"L x 26"D x 37"H	\$185.00	\$	-
18284-0476	29 lbs.	Buckskin Microfiber Stage Chair	25"L x 26"D x 37"H	\$185.00	\$	-
18284-0564	80 lbs.	Empire Chair White Leather	28"L x 32"D x 32"H	\$340.00	\$	-
18284-0621	80 lbs.	Empire Chair Black Leather	28"L x 32"D x 32"H	\$340.00	\$	-
18284-0449	75 lbs.	Ibiza White Leather Chair	31"L x 35"D x 32"H	\$470.00	\$	-
18284-0590	50 lbs.	Ibiza Black Leather Chair	31"L x 35"D x 32"H	\$470.00	\$	-
05035-0028	65 lbs.	Tulip Black Fabric Chair	26"L x 27"D x 35"H	\$205.00	\$	-
18284-0785	24 lbs.	Monarch Chair - Bright White	28"Square x 30"H	\$390.00	\$	-
Ottomans & Benches (Pg. 10)						
18184-0131	75 lbs.	Continental White Leather Curved Bench	70"L x 26"D x 19"H	\$310.00	\$	-
18184-0034	55 lbs.	Whisper White Leather Square Ottoman	40" Square x 17"H	\$260.00	\$	-
18184-0033	50 lbs.	Grammercy Charcoal Leather Square Ottoman	40" Square x 17"H	\$260.00	\$	-
18184-0179	30 lbs.	Metro Black Leather Square Ottoman	40" Square x 17"H	\$260.00	\$	-
18024-0002	30 lbs.	Grammercy Charcoal Leather Bench Ottoman	60"L x 24"D x 17"H	\$260.00	\$	-
18024-0003	30 lbs.	Whisper White Leather Bench Ottoman	60"L x 24"D x 17"H	\$260.00	\$	-
18024-0008	50 lbs.	Metro Black Leather Bench Ottoman	60"L x 24"D x 17"H	\$260.00	\$	-
18024-0062	60 lbs.	Chandler Red Leather Bench Ottoman	60"L x 24"D x 17"H	\$260.00	\$	-
18024-0061	30 lbs.	Parma Brown Leather Bench Ottoman	60"L x 24"D x 17"H	\$260.00	\$	-
05026-0005	60 lbs.	Hayden Black Wood Bench	67"L x 16"D x 17"H	\$130.00	\$	-
18184-0192	70 lbs.	Essentials White Leather Storage Ottoman	48"L x 24"D x 20"H	\$365.00	\$	-
18184-0038	70 lbs.	Whisper White Leather Round Ottoman	46" Round x 17"H	\$260.00	\$	-
18184-0036	65 lbs.	Grammercy Charcoal Leather Round Ottoman	46" Round x 17"H	\$260.00	\$	-
18184-0030	15 lbs.	Whisper White 1/4 Round Ottoman	34"L x 19"D x 17"H	\$155.00	\$	-
18184-0028	15 lbs.	Grammercy Charcoal 1/4 Round Ottoman	34"L x 19"D x 17"H	\$155.00	\$	-
Banquettes & Turning Beds (Pg. 11)						
18011-0011	150 lbs.	Essentials White Banquette (2 pcs)	60" Round x 48"H	\$780.00	\$	-
18011-0001	130 lbs.	Whisper White Leather Banquette, Tufted (2 pcs)	59" Round x 38"H	\$780.00	\$	-
18011-0002	130 lbs.	Grammercy Charcoal Leather Banquette (2 pcs)	59" Round x 38"H	\$780.00	\$	-
02082-0033	200 lbs.	Essentials White Leather Turning Bed	96"L x 48"D x 34"H	\$935.00	\$	-
Cube Ottomans (Pg. 11 & 12)						
18184-0198	15 lbs.	Regency Orange Cube	18" Square	\$100.00	\$	-
18184-0196	15 lbs.	Regency Teal Cube	18" Square	\$100.00	\$	-
18184-0197	15 lbs.	Regency Ruby Cube	18" Square	\$100.00	\$	-
18184-0200	15 lbs.	Regency Camel Cube	18" Square	\$100.00	\$	-
18184-0193	15 lbs.	Regency Apple Cube	18" Square	\$100.00	\$	-
18184-0199	15 lbs.	Regency Fuchsia Cube	18" Square	\$100.00	\$	-
18184-0129	15 lbs.	Cube Ottoman - White	18" Square	\$100.00	\$	-
18184-0128	15 lbs.	Cube Ottoman - Black	18" Square	\$100.00	\$	-
18184-0213-R	15 lbs.	Cube Ottoman - Red	18" Square	\$100.00	\$	-
18184-0213-G	15 lbs.	Cube Ottoman - Green	18" Square	\$100.00	\$	-
18184-0213-B	15 lbs.	Cube Ottoman - Blue	18" Square	\$100.00	\$	-
18184-0213-P	15 lbs.	Cube Ottoman - Purple	18" Square	\$100.00	\$	-
Charged (Pg. 12)						
10214-0001	235 lbs.	Essentials White Leather Turning Bed with Charging Station Insert	96"L x 48"D x 19"H	\$1,040.00	\$	-
22051-0001	40 lbs.	Boca Corner - Bright White	27"L x 27"D x 30"H	\$390.00	\$	-
22050-0001	30 lbs.	Boca Armless - Bright White	22"L x 27"D x 30"H	\$360.00	\$	-
22001-0001	80 lbs.	Aspen Pub Table - Charged	72"L x 26"D x 42"H	\$610.00	\$	-
22002-0002	55 lbs.	Aspen Cocktail Table - Charged	48"L x 24"D x 18"H	\$340.00	\$	-
22200-0001	230 lbs.	White Conference Table - Charged	96"L x 43"D x 30"H	\$820.00	\$	-
Occasional Tables (Pg. 13 & 14)						
12107-0008	28 lbs.	Tribeca End Table	24"L x 28"D x 22"H	\$180.00	\$	-
12055-0008	50 lbs.	Tribeca Cocktail Table	48"L x 28"D x 19"H	\$190.00	\$	-
12230-0005	38 lbs.	Tribeca Sofa/Console Table	48"L x 18"D x 30"H	\$200.00	\$	-
12107-0281	29 lbs.	Harmony End Table	24" Round x 22"H	\$180.00	\$	-
12055-0272	57 lbs.	Harmony Cocktail Table	51"L x 28"D x 18"H	\$190.00	\$	-
12230-0080	56 lbs.	Harmony Sofa/ConsoleTable	52"L x 18"D x 30"H	\$200.00	\$	-
18024-0011	48 lbs.	Novel Satin Steel Cocktail Table	46"L x 15"D x 16"H	\$260.00	\$	-
18024-0010	30 lbs.	Novel Satin Steel End Table	15" Square x 16"H	\$235.00	\$	-
99-12304-05	10 lbs.	Aria Red End Table	24"L x 20"D x 22"H	\$180.00	\$	-
99-12050-05	20 lbs.	Aria Red Cocktail Table	44"L x 20"D x 18"H	\$190.00	\$	-
99-12304-03	10 lbs.	Aria Green End Table	24"L x 20"D x 22"H	\$180.00	\$	-
99-12050-03	20 lbs.	Aria Green Cocktail Table	44"L x 20"D x 18"H	\$190.00	\$	-
99-12304-06	10 lbs.	Aria Blue End Table	24"L x 20"D x 22"H	\$180.00	\$	-
99-12050-06	20 lbs.	Aria Blue Cocktail Table	44"L x 20"D x 18"H	\$190.00	\$	-
99-12304-04	10 lbs.	Aria Purple End Table	24"L x 20"D x 22"H	\$180.00	\$	-
99-12050-04	20 lbs.	Aria Purple Cocktail Table	44"L x 20"D x 18"H	\$190.00	\$	-
99-12304-01	10 lbs.	Aria White End Table	24"L x 20"D x 22"H	\$180.00	\$	-
99-12050-01	20 lbs.	Aria White Cocktail Table	44"L x 20"D x 18"H	\$190.00	\$	-
99-12305-01	65 lbs.	Aria White Sofa/ConsoleTable	44"L x 20"D x 30"H	\$200.00	\$	-
99-12304-02	10 lbs.	Aria Charcoal End Table	24"L x 20"D x 22"H	\$180.00	\$	-

99-12050-02	20 lbs.	Aria Charcoal Cocktail Table	44"L x 20"D x 18"H	\$190.00	\$	-
99-12305-02	65 lbs.	Aria Charcoal Sofa/Console Table	44"L x 20"D x 30"H	\$200.00	\$	-
12107-0065	20 lbs.	Reno End Table	25" Round x 21"H	\$165.00	\$	-
12055-0061	45 lbs.	Reno Cocktail Table	45"L x 32"D x 18"H	\$185.00	\$	-
12230-0023	30 lbs.	Reno Sofa/Console Table	46"L x 17"D x 29"H	\$205.00	\$	-
12107-0282	35 lbs.	Vivid End Table	26" Square x 21"H	\$180.00	\$	-
12055-0273	50 lbs.	Vivid Cocktail Table	50"L x 24"D x 16"H	\$190.00	\$	-
12230-0081	55 lbs.	Vivid Sofa/Console Table	50"L x 24"D x 30"H	\$200.00	\$	-
12055-0318	55 lbs.	Club Cocktail Table w/ built in LED Lighting	44"L x 22"D x 18"H	\$260.00	\$	-
12107-0331	40 lbs.	Club End Table w/ built in LED Lighting	22" Square x 18"H	\$235.00	\$	-
12003-0038	15 lbs.	Rose Table	17" Round x 17"H	\$205.00	\$	-
12003-0039	20 lbs.	Zanzibar Table	17" Square	\$205.00	\$	-
12107-0297	55 lbs.	Cube, White 24" End Table	24" Square x 21"H	\$185.00	\$	-
12107-0296	50 lbs.	Cube, Black 24" End Table	24" Square x 21"H	\$185.00	\$	-
12078-0012	50 lbs.	Cube, White 30" Cocktail Table	30" Square x 16"H	\$185.00	\$	-
12078-0011	50 lbs.	Cube, Black 30" Cocktail Table	30" Square x 16"H	\$185.00	\$	-
12055-0286	40 lbs.	Cube, White 24" Cocktail Table	24" Square x 16"H	\$180.00	\$	-
12055-0285	45 lbs.	Cube, Black 24" Cocktail Table	24" Square x 16"H	\$180.00	\$	-
12107-0467	15 lbs.	Hylton Table	18"L x 12"D x 28"H	\$160.00	\$	-
12003-0056	15 lbs.	Phoebe Table - Yellow	17" Round x 22"H	\$120.00	\$	-
12003-0052	15 lbs.	Phoebe Table - Lime Green	17" Round x 22"H	\$120.00	\$	-
12003-0053	15 lbs.	Phoebe Table - Rose	17" Round x 22"H	\$120.00	\$	-
12003-0051	15 lbs.	Phoebe Table - Gold	17" Round x 22"H	\$120.00	\$	-
12003-0074	15 lbs.	Phoebe Table - Teal	17" Round x 22"H	\$120.00	\$	-
Bars & Bar Backs (Pg. 15)						
05012-0001	160 lbs.	Manhattan Martini Bar	63"L x 29"D x 42"H	\$680.00	\$	-
05012-0026	185 lbs.	VIP Frosted Plexi Glow Bar 6'	72"L x 24"D x 42"H	\$680.00	\$	-
05012-0024	130 lbs.	VIP Frosted Plexi Glow Bar 4'	48"L x 24"D x 42"H	\$575.00	\$	-
05012-0054	70 lbs.	White Bar - 2 Shelf	48"L x 16"D x 42"H	\$310.00	\$	-
05012-0053	70 lbs.	Black Bar - 2 Shelf	48"L x 16"D x 42"H	\$310.00	\$	-
12112-0010	60 lbs.	Blox Bar Back	30"L x 16"D x 86"H	\$390.00	\$	-
05001-0017	155 lbs.	Piazza Bar Back - Black	44"L x 12"D x 80"H	\$365.00	\$	-
05001-0018	155 lbs.	Piazza Bar Back - White	44"L x 12"D x 80"H	\$365.00	\$	-
Bar Stools (Pg. 16 & 17)						
05237-0262	15 lbs.	Vienna Stool - Teal	17" Square x 39"H	\$190.00	\$	-
05237-0263	15 lbs.	Vienna Stool - Orange	17" Square x 39"H	\$190.00	\$	-
05237-0264	15 lbs.	Vienna Stool - Smoke	17" Square x 39"H	\$190.00	\$	-
05237-0039	15 lbs.	Criss Cross Bar Stool - White	15"W x 19"D x 41"H	\$170.00	\$	-
05237-0038	15 lbs.	Criss Cross Bar Stool - Espresso	15"W x 19"D x 41"H	\$170.00	\$	-
05237-0036	15 lbs.	Escape Bar Stool - Natural Maple	16" Square x 41"H	\$145.00	\$	-
99-05237-01	20 lbs.	Silk Back Bar Stool - Black	17"W x 18"D x 42"H	\$160.00	\$	-
99-05237-02	20 lbs.	Silk Back Bar Stool - White	17"W x 18"D x 42"H	\$160.00	\$	-
99-05237-03	20 lbs.	Silk Back Bar Stool - Green	17"W x 18"D x 42"H	\$160.00	\$	-
99-05237-04	20 lbs.	Silk Back Bar Stool - Purple	17"W x 18"D x 42"H	\$160.00	\$	-
99-05237-05	20 lbs.	Silk Back Bar Stool - Red	17"W x 18"D x 42"H	\$160.00	\$	-
99-05237-06	20 lbs.	Silk Back Bar Stool - Blue	17"W x 18"D x 42"H	\$160.00	\$	-
05237-0221	20 lbs.	Euro Bar Stool - Black	22"W x 24"D x 42"H	\$160.00	\$	-
05237-0231	40 lbs.	Hourglass Bar Stool - White	18"W x 20"D x 43"H	\$175.00	\$	-
05237-0230	40 lbs.	Hourglass Bar Stool - Black	18"W x 20"D x 43"H	\$175.00	\$	-
05237-0160	35 lbs.	Equino Bar Stool - Black	15"W x 13"D x 35"H	\$175.00	\$	-
05237-0041	35 lbs.	Equino Bar Stool - White	15"W x 13"D x 35"H	\$175.00	\$	-
05237-0169	25 lbs.	Caprice Bar Stool - Black	25"W x 26"D x 44"H	\$175.00	\$	-
05237-0042	15 lbs.	Sonic Bar Stool - Black	22"W x 23"D x 42"H	\$145.00	\$	-
05237-0215	15 lbs.	Marcus Bar Stool - Gunmetal	18"W(at footbase) x 29"H	\$130.00	\$	-
05237-0156	20 lbs.	Regal Stool - Brown	19"W x 24"D x 45"H	\$175.00	\$	-
Café Chairs (Pg. 17 & 18)						
05035-0031	15 lbs.	Vienna Chair - Orange	21" Square x 32"H	\$120.00	\$	-
05035-0030	15 lbs.	Vienna Chair - Teal	21" Square x 32"H	\$120.00	\$	-
05035-0032	15 lbs.	Vienna Chair - Smoke	21" Square x 32"H	\$120.00	\$	-
99-05035-10	20 lbs.	Silk Back Armless Chair - Black	17"W x 18"D x 34"H	\$100.00	\$	-
99-05035-11	20 lbs.	Silk Back Armless Chair - White	17"W x 18"D x 34"H	\$100.00	\$	-
99-05035-12	20 lbs.	Silk Back Armless Chair - Green	17"W x 18"D x 34"H	\$100.00	\$	-
99-05035-13	20 lbs.	Silk Back Armless Chair - Purple	17"W x 18"D x 34"H	\$100.00	\$	-
99-05035-14	20 lbs.	Silk Back Armless Chair - Red	17"W x 18"D x 34"H	\$100.00	\$	-
99-05035-15	20 lbs.	Silk Back Armless Chair - Blue	17"W x 18"D x 34"H	\$100.00	\$	-
05035-0009	10 lbs.	Escape Chair - Natural Maple	17"W x 16"D x 32"H	\$100.00	\$	-
05035-0008	10 lbs.	Leslie Chair - White	17"W x 21"D x 31"H	\$90.00	\$	-
05035-0011	15 lbs.	Criss Cross Chair - White	17"W x 21"D x 35"H	\$115.00	\$	-
05035-0010	15 lbs.	Criss Cross Chair - Espresso	17"W x 21"D x 35"H	\$115.00	\$	-
14233-0016	10 lbs.	Sonic Chair - Black	20"W x 21"D x 32"H	\$100.00	\$	-
05035-0023	15 lbs.	Elio Chair	17" Square x 33"H	\$100.00	\$	-
14233-0025	20 lbs.	Caprice Chair - Black	25"W x 24"D x 32"H	\$100.00	\$	-
14233-0005	20 lbs.	Comet Stack Arm Chair - Black	23"W x 22"D x 32"H	\$140.00	\$	-
14233-0006	15 lbs.	Comet Stack Chair - Black	19"W x 22"D x 32"H	\$130.00	\$	-
14233-0034	10 lbs.	Trend Chair - Black	19"W x 18"D x 33"H	\$130.00	\$	-
14233-0038	10 lbs.	Trend Chair - White	19"W x 18"D x 33"H	\$130.00	\$	-
05221-0039	20 lbs.	Regal (Parson) Chair - Brown	19"W x 23"D x 38"H	\$145.00	\$	-
Bar Tables (Pg. 19 & 20)						
99-05245-01	45 lbs.	Euro 30" Round Bar Table - Black/Black	30" Round x 42"H	\$180.00	\$	-
99-05245-02	55 lbs.	Euro 36" Round Bar Table - Black/Black	36" Round x 42"H	\$185.00	\$	-
99-05245-04	45 lbs.	Silk 30" Round Bar Table - Black/Chrome	30" Round x 42"H	\$180.00	\$	-
99-05245-05	55 lbs.	Silk 36" Round Bar Table - Black/Chrome	36" Round x 42"H	\$185.00	\$	-

99-05245-07	45 lbs.	Park Ave 30" Round Bar Table - Maple/Chrome	30" Round x 42"H	\$180.00	\$	-
99-05245-08	55 lbs.	Park Ave 36" Round Bar Table - Maple/Chrome	36" Round x 42"H	\$185.00	\$	-
05012-0002	35 lbs.	Chardonnay Glass & Chrome Bar Table	31" Round x 42"H	\$260.00	\$	-
05204-0001	75 lbs.	Aspen Pub Table	72"L x 26"D x 42"H	\$520.00	\$	-
99-05245-10	45 lbs.	Blanco 30" Round Bar Table - White/Chrome	30" Round x 42"H	\$180.00	\$	-
99-05245-11	55 lbs.	Blanco 36" Round Bar Table - White/Chrome	36" Round x 42"H	\$185.00	\$	-
99-05245-12	50 lbs.	Blanco Square Bar Table - White/Chrome	24" Square x 42"H	\$180.00	\$	-
99-05245-13	40 lbs.	Blanco Rectangle Bar Table - White/Chrome	72"L x 24"D x 42"H	\$285.00	\$	-
99-05245-14	40 lbs.	City 30" Round Bar Table - Maple/Black	30" Round x 42"H	\$180.00	\$	-
99-05245-15	50 lbs.	City 36" Round Bar Table - Maple/Black	36" Round x 42"H	\$185.00	\$	-
99-05245-16	40 lbs.	Summit 30" Round Bar Table - White/Black	30" Round x 42"H	\$180.00	\$	-
99-05245-17	50 lbs.	Summit 36" Round Bar Table - White/Black	36" Round x 42"H	\$185.00	\$	-
99-05245-20	50 lbs.	Spectrum Red Bar Table	24" Square x 42"H	\$200.00	\$	-
99-05245-19	50 lbs.	Spectrum Green Bar Table	24" Square x 42"H	\$200.00	\$	-
99-05245-21	50 lbs.	Spectrum Blue Bar Table	24" Square x 42"H	\$200.00	\$	-
99-05245-18	50 lbs.	Spectrum Purple Bar Table	24" Square x 42"H	\$200.00	\$	-
Café Tables (Pg. 20 & 21)						
99-05036-01	40 lbs.	Euro 30" Round Cafe Table - Black/Black	30" Round x 29"H	\$180.00	\$	-
99-05036-02	50 lbs.	Euro 36" Round Cafe Table - Black/Black	36" Round x 29"H	\$185.00	\$	-
99-05036-04	40 lbs.	Silk 30" Round Cafe Table - Black/Chrome	30" Round x 29"H	\$180.00	\$	-
99-05036-05	50 lbs.	Silk 36" Round Cafe Table - Black/Chrome	36" Round x 29"H	\$185.00	\$	-
99-05036-07	40 lbs.	Park Ave 30" Round Cafe Table - Maple/Chrome	30" Round x 29"H	\$180.00	\$	-
99-05036-08	50 lbs.	Park Ave 36" Round Cafe Table - Maple/Chrome	36" Round x 29"H	\$185.00	\$	-
99-05036-14	45 lbs.	City 30" Round Cafe Table - Maple/Black	30" Round x 29"H	\$180.00	\$	-
99-05036-15	51 lbs.	City 36" Round Cafe Table - Maple/Black	36" Round x 29"H	\$185.00	\$	-
99-05036-16	45 lbs.	Summit 30" Round Cafe Table - White/Black	30" Round x 29"H	\$180.00	\$	-
99-05036-17	55 lbs.	Summit 36" Round Cafe Table - White/Black	36" Round x 29"H	\$185.00	\$	-
99-05036-10	40 lbs.	Blanco 30" Round Cafe Table - White/Chrome	30" Round x 29"H	\$180.00	\$	-
99-05036-11	50 lbs.	Blanco 36" Round Cafe Table - White/Chrome	36" Round x 29"H	\$185.00	\$	-
99-05036-12	50 lbs.	Blanco Square Cafe Table - White/Chrome	24" Square x 29"H	\$180.00	\$	-
99-05036-13	85 lbs.	Blanco Rectangle Cafe Table - White/Chrome	72"L x 24"D x 29"H	\$285.00	\$	-
99-05036-18	50 lbs.	Spectrum Purple Café Table	24" Square x 29"H	\$195.00	\$	-
99-05036-20	50 lbs.	Spectrum Red Café Table	24" Square x 29"H	\$195.00	\$	-
99-05036-19	50 lbs.	Spectrum Green Café Table	24" Square x 29"H	\$195.00	\$	-
99-05036-21	50 lbs.	Spectrum Blue Café Table	24" Square x 29"H	\$195.00	\$	-
05090-0001	90 lbs.	Aspen Dining Table	72"L x 30"D x 30"H	\$440.00	\$	-
Office Seating (Pg. 22 & 23)						
14136-0002	45 lbs.	Tamiri Black Leather High Back	25"L x 27"D x 45"H	\$235.00	\$	-
14176-0007	45 lbs.	Tamiri Black Leather Mid Back	27" Square x 39"H	\$200.00	\$	-
14128-0002	45 lbs.	Tamiri Black Leather Guest Chair	25"L x 26"D x 37"H	\$185.00	\$	-
14136-0010	45 lbs.	Accord White Leather High Back	25" Square x 44"H	\$290.00	\$	-
14136-0081	45 lbs.	Accord Black Leather High Back	25" Square x 44"H	\$290.00	\$	-
14250-0013	35 lbs.	Goal Black Task Chair With Arms	25" Square x 39"H	\$150.00	\$	-
14250-0014	30 lbs.	Goal Black Task Chair Armless	21"L x 25"D x 39"H	\$140.00	\$	-
14136-0016	40 lbs.	Enterprise High Back Black Fabric Conference Chair	25"L x 27"D x 45"H	\$205.00	\$	-
14176-0008	35 lbs.	Enterprise Mid Back Black Fabric Conference Chair	24"L x 26"D x 39"H	\$185.00	\$	-
14128-0023	30 lbs.	Enterprise Guest Black Fabric Conference Chair	25"L x 27"D x 37"H	\$170.00	\$	-
14307-0003	45 lbs.	Goal Black Drafting Stool - Arms	25"L x 24"D x 48"H	\$160.00	\$	-
14307-0004	40 lbs.	Goal Black Drafting Stool - Armless	21"L x 24"D x 48"H	\$150.00	\$	-
Conference Tables (Pg. 23)						
14062-0256	175 lbs.	Conference Rectangle Table 6' - Maple	72"L x 36"D x 30"H	\$435.00	\$	-
14062-0109	175 lbs.	Conference Rectangle Table 6' - Black	72"L x 36"D x 30"H	\$435.00	\$	-
14062-0110	175 lbs.	Conference Rectangle Table 6' - Mahogany	72"L x 36"D x 30"H	\$435.00	\$	-
14062-0281	175 lbs.	Conference Rectangle Table 6' - White	72"L x 36"D x 30"H	\$460.00	\$	-
14062-0257	220 lbs.	Conference Rectangle Table 8' - Maple	96"L x 48"D x 30"H	\$470.00	\$	-
14062-0113	220 lbs.	Conference Rectangle Table 8' - Black	96"L x 48"D x 30"H	\$470.00	\$	-
14062-0114	220 lbs.	Conference Rectangle Table 8' - Mahogany	96"L x 48"D x 30"H	\$470.00	\$	-
14062-0282	220 lbs.	Conference Rectangle Table 8' - White	96"L x 48"D x 30"H	\$495.00	\$	-
14062-0252	220 lbs.	Conference Oval Racetrack Table 8' - Black	96"L x 48"D x 30"H	\$470.00	\$	-
14062-0260	220 lbs.	Conference Oval Racetrack Table 8' - Mahogany	96"L x 48"D x 30"H	\$470.00	\$	-
14062-0259	175 lbs.	Conference Oval Racetrack Table 6' - Black	72"L x 36"D x 30"H	\$435.00	\$	-
14062-0254	175 lbs.	Conference Oval Racetrack Table 6' - Mahogany	72"L x 36"D x 30"H	\$435.00	\$	-
Office Furniture (Pg. 24 & 25)						
14309-0001	125 lbs.	Computer Kiosk - Black	24" Square x 42"H	\$380.00	\$	-
14179-0005	125 lbs.	Computer Kiosk - White	24" Square x 42"H	\$380.00	\$	-
14061-0002	20 lbs.	Computer Counter - Graphite	48"L x 24"D x 42"H	\$185.00	\$	-
14076-0014	20 lbs.	Computer Desk - Graphite	48"L x 24"D x 29"H	\$175.00	\$	-
14029-0096	55 lbs.	5 Shelf Bookcase - Mahogany	36"L x 12"D x 72"H	\$365.00	\$	-
14029-0098	55 lbs.	5 Shelf Bookcase - Black	36"L x 12"D x 72"H	\$365.00	\$	-
14072-0108	225 lbs.	Black Credenza	60"L x 20"D x 29"H	\$340.00	\$	-
14083-0105	290 lbs.	Black Double Pedestal Desk	60"L x 30"D x 29"H	\$390.00	\$	-
14072-0122	175 lbs.	Maple Credenza	72"L x 20"D x 29"H	\$495.00	\$	-
14083-0293	290 lbs.	Maple Double Pedestal Desk	60"L x 30"D x 29"H	\$470.00	\$	-
14143-0140	125 lbs.	Lateral File Maple - 2 Drawer w/ Lock	36"L x 20"D x 29"H	\$330.00	\$	-
14072-0038	225 lbs.	Genoa Storage Credenza - Mahogany - 2 Drawer	66"L x 20"D x 29"H	\$340.00	\$	-
14072-0039	200 lbs.	Genoa Kneespace Storage Credenza - Mahogany	66"L x 20"D x 29"H	\$315.00	\$	-
14083-0117	290 lbs.	Genoa Exec. Desk - Mahogany - Double Pedestal	72"L x 36"D x 29"H	\$365.00	\$	-
14072-0042	250 lbs.	Presidential Kneespace Credenza - Mahogany	66"L x 24"D x 29"H	\$415.00	\$	-
14083-0125	250 lbs.	Presidential Executive Desk - Mahogany	72"L x 36"D x 29"H	\$515.00	\$	-

14143-0060	220 lbs.	Presidential Lateral File - Mahogany	36"L x 24"D x 29"H	\$325.00	\$	-
05088-0366	155 lbs.	Hayden Table - Black Wood	78"L x 36"D x 30"H	\$420.00	\$	-
05088-0365	70 lbs.	Vivid Café - Square Table Glass	42" Square x 30"H	\$315.00	\$	-
05088-0364	90 lbs.	Vivid Café - Rectangle Table Glass	60"L x 36"D x 30"H	\$365.00	\$	-
Metal File & Storage Cabinets (Pg. 26)						
14148-0001	35 lbs.	2 Drawer Vertical File - Letter Size Locking Black	15"L x 25"D x 29"H	\$125.00	\$	-
14147-0001	35 lbs.	2 Drawer Vertical File - Legal Size Locking Black	18"L x 25"D x 29"H	\$160.00	\$	-
14148-0002	45 lbs.	4 Drawer Vertical File - Letter Size Locking Black	15"L x 25"D x 52"H	\$165.00	\$	-
14147-0002	45 lbs.	4 Drawer Vertical File - Legal Size Locking Black	18"L x 25"D x 52"H	\$185.00	\$	-
14143-0006	100 lbs.	2 Drawer Lateral File - Locking Black	36"L x 18"D x 27"H	\$165.00	\$	-
14143-0144	125 lbs.	2 Drawer Lateral File - Locking Black	36"L x 20"D x 29"H	\$195.00	\$	-
14143-0008	170 lbs.	4 Drawer Lateral File - Locking Black	36"L x 18"D x 54"H	\$210.00	\$	-
14034-0015	135 lbs.	Storage Cabinet - Locking Black	36"L x 18"D x 72"H	\$210.00	\$	-
Pedestals (Pg. 27)						
12091-0023	50 lbs.	Display Pedestal 14x42 Black	14" Square x 42"H	\$250.00	\$	-
12091-0004	120 lbs.	Display Pedestal 24x42 Black	24" Square x 42"H	\$305.00	\$	-
12091-0002	55 lbs.	Display Pedestal 18x42 Black	18" Square x 42"H	\$280.00	\$	-
12091-0030	50 lbs.	Display Pedestal 14x42 White	14" Square x 42"H	\$250.00	\$	-
12091-0024	45 lbs.	Display Pedestal 14x36 Black	14" Square x 36"H	\$215.00	\$	-
12091-0034	75 lbs.	Display Pedestal 24x36 Black	24" Square x 36"H	\$305.00	\$	-
12091-0031	45 lbs.	Display Pedestal 14x36 White	14" Square x 36"H	\$215.00	\$	-
12091-0033	75 lbs.	Display Pedestal 24x36 White	24" Square x 36"H	\$305.00	\$	-
12091-0025	40 lbs.	Display Pedestal 14x30 Black	14" Square x 30"H	\$195.00	\$	-
12091-0003	80 lbs.	Display Pedestal 24x30 Black	24" Square x 30"H	\$290.00	\$	-
12091-0001	45 lbs.	Display Pedestal 18x30 Black	18" Square x 30"H	\$205.00	\$	-
12091-0032	40 lbs.	Display Pedestal 14x30 White	14" Square x 30"H	\$195.00	\$	-
14309-0001	125 lbs.	Locking Pedestal Black	24" Square x 42"H	\$380.00	\$	-
14179-0005	125 lbs.	Locking Pedestal White	24" Square x 42"H	\$380.00	\$	-
Miscellaneous Items (Pg. 28)						
14189-0077	50 lbs.	Stanchion Chrome	41"H	\$55.00	\$	-
11-517	2 lbs.	Stanchion Rope - Red Velour	6' Length	\$30.00	\$	-
14308-0010	8 lbs.	Literature Stand - Aluminum	14.75"W x 12"D x 53.5"H	\$140.00	\$	-
14308-0009	8 lbs.	Literature Stand - Black	14.75"W x 12"D x 53.5"H	\$140.00	\$	-
14308-0005	7 lbs.	Literature Rack - Black Metal	10.5"W x 9.5"D x 57"H	\$145.00	\$	-
01209-0003	50 lbs.	Compact Refrigerator White - 4.0 Cu Ft	19"W x 21"D x 33.5"H	\$260.00	\$	-
99-12091-01	78 lbs.	Plexi Display Unit	18" Square x 68"H	\$315.00	\$	-
14523-0001	9.25 lbs.	iPad® Stand Black	14.25"W x 41.75"H	\$160.00	\$	-
14523-0002	9.25 lbs.	iPad® Stand Silver	14.25"W x 41.75"H	\$160.00	\$	-
Lighting (Pg. 29)						
09417-0001 BSW	4 lbs.	Brushed Steel Table Lamp - White	26"H	\$90.00	\$	-
09392-0001 BSW	8 lbs.	Brushed Steel Floor Lamp - White	66"H	\$130.00	\$	-
09417-0001 BN	7 lbs.	Brushed Nickel Table Lamp - White	29"H	\$90.00	\$	-
09392-0001 BN	12 lbs.	Brushed Nickel Floor Lamp - White	60"H	\$130.00	\$	-
09417-0001 RB	7 lbs.	Rubbed Bronze Table Lamp - White	28"H	\$90.00	\$	-
09392-0001 RB	11 lbs.	Rubbed Bronze Floor Lamp - White	60"H	\$130.00	\$	-
09417-0001 BSR	4 lbs.	Brushed Steel Table Lamp - Red	26"H	\$90.00	\$	-
09392-0001 BSR	8 lbs.	Brushed Steel Floor Lamp - Red	66"H	\$130.00	\$	-
50013	71 lbs.	Neutrino Steel Floor Lamp - Steel	67"H	\$130.00	\$	-



Please make payments payable to: American Furniture Rental

DO NOT MAIL Order Form

PO Box 65035

E-mail / Fax Order Form ONLY Baltimore, MD 21264-5035

Total of Pages Above		\$	-
Late Fee %		\$	-
Sub Total		\$	-
Sales Tax %		\$	-
TOTAL Amount Due		\$	-

Company Name	-	Credit Card Type	
Address		Credit Card #	
City		Card Holder	
State		Expiration Date	
Zip Code		Security Code	
Name / Date of Show	-	Signature	
Booth Number	-	Date	
Contact Name	-		
Contact Phone		E-Mail Address	
Contact Cell	-	Fax	
Special Instructions			



Minneapolis

Convention Center

1301 Second Avenue South
Minneapolis, Minnesota 55403-2781
(612) 335-6000

2017

Prices effective
1/1/17 thru 12/31/17

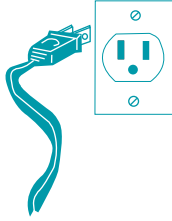

Exhibitor Service Information - (612) 335-6550
Fax - (612) 335-6600 TDD (612) 335-6500

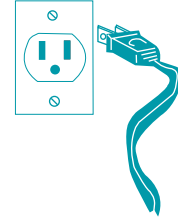

ELECTRICAL SERVICE ORDER FORM

ONLINE ORDERING AVAILABLE AT:
www.minneapolisconventioncenter.com

For your security DO NOT email credit card #

SAVE MONEY - DISCOUNTED ADVANCE RATE

Payment and order received by Convention Center fourteen (14) days prior to 1st show day

SAVE TIME

Send this form and payment directly to the Convention Center

Do not send these forms to the decorator

Pay all Convention Center Service Orders **with one Check** Payable to: **“Minneapolis Convention Center”**

AVOID CONFUSION

TO AVOID DOUBLE BILLING: When faxing a credit card order, **DO NOT** mail your original forms

Provide complete customer and payment information

Read instructions and policies on back of form

For mailed orders, please keep yellow copy, send one (1) copy to the Convention Center

DID YOU KNOW ??

OTHER SERVICES OFFERED AT THE MINNEAPOLIS CONVENTION CENTER:



Cleaning and Porter Service



Plumbing/Compressed Air Service



Guest Services



Coffee and/or rolls in your booth. Contact the Convention Center Food Service at (612) 335-6045
[and online @ www.kelber.com](http://www.kelber.com)



Questions
Contact Exhibitor Services
(612) 335-6550



Minneapolis Convention Center
 1301 Second Avenue South
 Minneapolis, Minnesota 55403-2781
 (612) 335-6000 FAX (612) 335-6600
 Exhibitor Service Information (612) 335-6550

Electrical Service Order Form

Prices Effective 1/1/17 thru 12/31/17 **2017**

Name of Event _____	Date of Event _____	Booth Number(s) _____
Firm Name _____	E-Mail Address _____	
<input type="checkbox"/> Check if new address		
Street Address _____	Contact Person _____	
City _____	State _____	Zip _____ Phone # _____

Payment Notice: Advance Rates apply only to orders paid in full and received 14 DAYS PRIOR TO THE FIRST SCHEDULED SHOW DAY. Standard Rates must be paid at move-in for all other orders. NO EXCEPTIONS.

Standard Electrical Service (Tax does not apply)

120 volts - per single receptacle

Qty.	Advance Rate	Standard Rate	Qty.	Advance Rate	Standard Rate
10 amp (1100 watts) _____	107.00	133.00	20 amp (2200 watts) _____	137.00	169.00

The MCC only places power according to the number of outlets ordered. This is brought to the booth in the most convenient manner. Specific placement of power in the booth will require a floor plan and will incur labor. We do not divide electrical into smaller increments for you. You may redistribute power yourself with UL approved extension cords, power strips, etc.

24 hour Service Required? Add 50% to Service Connection Charge \$ _____

Special Electrical Service (Tax does not apply)

Special electrical service will require labor. Please call for labor estimate.

Service will not be installed without pre-paid labor. Please notify service desk when equipment is in place and ready for connection.

208 volts single phase- per single connection

208 volts 3-phase - per single connection

Qty.	Advance Rate	Standard Rate	Qty.	Advance Rate	Standard Rate
10 amp (2080 watts) _____	158.00	\$199.00	10 amp (3600 watts) _____	173.00	\$217.00
20 amp (4160 watts) _____	198.00	240.00	20 amp (7200 watts) _____	309.00	388.00
30 amp (6240 watts) _____	226.00	280.00	30 amp (10,800 watts) _____	346.00	436.00
40 amp (8320 watts) _____	294.00	365.00	40 amp (14,400 watts) _____	435.00	541.00

Other 120/280 volt, 240 volt and 480 volt service available by special order.

Call Exhibitor Service Department for pricing (612) 335-6550

Non-Taxable

Total \$ _____

Labor for Special Electrical Work (Tax does not apply)

Including repairs, special placement and tracing malfunctions. Labor time will be charged in one-half (1/2) hour increments. Minimum charge of one-half (1/2) hour.

Rate * Labor charges will be assessed at time of installation and payment in full must be received prior to service.

Monday through Friday, 8:00 a.m. - 4:30 p.m. (except Holidays)	118.00/hr.	
Monday through Friday, 4:30 p.m. - 6:30 p.m. (except Holidays)	177.00/hr.	
Monday through Friday, 6:30 p.m. - 7:00 a.m., all day Saturday & Sunday	236.00/hr.	

Non-Taxable

Total \$ _____

Service Accessories (Tax does apply)

Accessories do not include power. Be sure to order power as needed. Accessories must be picked up at Service Desk.

	Qty.	
Extension Cord (25 Feet)	_____	35.00
Triple Tap (3 Outlets)	_____	16.00
Power Strip with surge protection	_____	35.00

Total

Tax 7.775%

\$ _____
 \$ _____

Any balance due during or at the end of the show will be billed directly to the credit card number provided. By your signature below, you acknowledge and agree to these terms and authorize MCC to bill your credit card. **Please DO NOT email credit card #.**

Payment must be in U.S. Funds. Make checks payable to Minneapolis Convention Center.

Amer. Express Company Check or Money Order # _____

Discover Credit Card # _____ Exp Date _____

MasterCard Cardholders Name _____

Visa Authorized Signature _____

Order Total \$ _____

For MCC Use Only	
ID No.	\$ _____
Entered	Date _____
P.O. No. _____	
P.O. needs to accompany order	

MINNEAPOLIS CONVENTION CENTER
1301 Second Avenue South - Minneapolis, Minnesota 55403-2781
Request for Electrical Service
(612) 335-6550

IMPORTANT CONDITIONS AND REGULATIONS

1. **ADVANCE ORDERS:** To receive advance rate, orders must be received a minimum of 14 days prior to first show day.
2. **RETURNED CHECK FEE: A \$30.00 service charge will be assessed for any returned checks.**
3. **CONDITIONS FOR PROCESSING SERVICE ORDER FORMS:**
 - a. Payment **IN FULL, IN U.S. FUNDS** must accompany service order form.
 - b. Date payment is received by the Minneapolis Convention Center will determine the applicable rate.
 - c. All order form information must be completed in full for order to be processed. Incomplete order forms could result in processing delays resulting in slow service installation.
 - d. No service will be installed until full payment is received.
 - e. Cancellations:
Refunds will be computed as follows:
 1. After installation - **NO REFUND.**
 2. Before installation, but 6 days or less prior to first scheduled move-in-day - **85% REFUND.**
 3. Before installation and more than 6 days prior to first scheduled move-in day - **FULL REFUND.**
4. Rates quoted for all connections cover only the bringing of service to the booth in the most convenient manner as determined by the Minneapolis Convention Center and **DO NOT** include connecting equipment to provided services. Special placement or relocation of service will result in a labor charge. Payment **IN FULL** must be rendered for such services before the close of event day.
5. Advance orders will receive priority service.
6. Claims will not be considered unless filed in writing by exhibitor prior to close of show.
7. Requests for special voltage and/or other "Special Requirements" (see form) must be received by the Minneapolis Convention Center 30 days prior to scheduled exhibitor arrival and move-in.
8. Use of open clip sockets, latex or lamp cord wire, unapproved duplex or triplex attachment plugs in exhibits is prohibited.
9. Standard wall, column and permanent building electrical outlets are not a part of booth space and are not to be used by exhibitors unless specified otherwise.
10. Under **NO** circumstances shall anyone other than "house electrician" make electrical connections.
11. Special equipment requiring company engineers or technicians for assembly, servicing, preparatory work and operation may be executed without "house electrician," however, all service connections and overload protection to such equipment must be made by "house electrician" only.
12. All equipment must be properly tagged or marked with complete information as to the type and/or amount of current voltage, phase, frequency, horsepower, etc. required.
13. All materials and equipment furnished by the Minneapolis Convention Center for this service order shall remain the property of the Minneapolis Convention Center and shall be removed **ONLY** by the Minneapolis Convention Center at the close of the show.
14. The Minneapolis Convention Center electricians are authorized to cut floor coverings to permit installation of service unless otherwise directed.
15. All exhibitors' **120 Volt** cords must be of the 3 wire, grounded type. All exposed non-current carrying metal parts of fixed equipment, which are liable to be energized, shall be grounded.
16. The Minneapolis Convention Center reserves the right to refuse connection to any exhibitor whose equipment is deemed unsafe by the Minneapolis Convention Center's electrical supervisors.
17. Booth power will be turned on 1 hour prior to event opening and turned off 30 minutes after close. 24 hour service will be provided only to those locations that have ordered and paid for 24 hour service.
18. Power requirements crossing aisles will not be installed unless approved by show management.
19. Prices are based upon current wage rates and are subject to change without notice.
20. Refunds or credits in excess of \$15.00 dollars will be made automatically. Claims for refunds for less than \$15.00 must be made in writing.

Standard Electrical Services.....	120 Volt, A.C., Single Phase, 60 Cycle
	208 Volt, A.C., Single Phase, 60 Cycle
	208 Volt, A.C., Three Phase, 60 Cycle
Special Voltage Available on Request	480 Volt, A.C., Three Phase, 60 Cycle
	240 Volt, A.C., Three Phase, 60 Cycle



INTERNET - NETWORK / TELEPHONE SERVICE CONTRACT

Exhibitor Company Name:	Show Name:
Billing Company Name:	Show Dates: / / To / /
Billing Company Address:	Incentive Order Deadline: 14 Days Prior to 1st Day of Show Move-in
City, State / Country, Zip:	Booth / Room #:
Contact Name:	Phone Number: () -
Contact Email:	Cell Number: () -
On-Site Contact:	On-Site Number: () -

When your order is processed, you will receive an email with a link to Smart City Networks payment portal. Payment in full is required prior to the event.

With execution of this document the Customer hereby authorizes Smart City to provide services as requested herein, is authorized to request such services and acknowledges full and complete understanding of the Terms and Conditions and Attachments.

View complete Terms & Conditions at: orders.smartcitynetworks.com/tc.aspx?center=099

Print Authorized Name Accepting Terms and Conditions:	Authorized Signature Accepting Terms and Conditions:
---	--

<p>Dedicated Wired Internet Routers Allowed</p> <p>Connection speeds of 3Mbps and up</p> <p>Required for:</p> <ul style="list-style-type: none"> Web Casting HD Streaming Routers(wired or wireless) <p>Includes 5 Static Public IP Addresses</p>	<p>Premium Wired Internet No wired or wireless routers</p> <p>Shared Connection speeds up to 10Mbps</p> <p>Recommended for:</p> <ul style="list-style-type: none"> Wired Cyber Cafe Social Media Feeds Multi Media Downloads <p>Includes 1 Static Private IP Address</p>	<p>Basic Wired Internet No wired or wireless routers</p> <p>Shared Connection speeds up to 1.54Mbps</p> <p>Recommended for:</p> <ul style="list-style-type: none"> Email Surfing the Internet <p>Supports 1 device only</p>
---	--	--

Wireless services are NOT included on this form – please contact us for specific rates.

ORDER ONLINE: orders.smartcitynetworks.com/ordering.aspx

Incentive rate applies to orders received with payment 14 days prior to 1st day of show move-in

1. Shared Internet Services – Routers Prohibited	QTY	Incentive	Base	On-Site	Total
a. Premium Internet Service		\$1,095	\$1,395	\$1,674	
b. Additional Devices for Premium Service		\$150	\$185	\$222	
c. Upgrade to Public IP Address for Premium Internet Service		\$199	\$299	\$358	
d. Basic Internet Service		\$695	\$895	\$1,074	
2. Dedicated Internet Services – Routers Supported					
a. Dedicated 3Mbps		\$3,495	\$4,370	\$5,244	
b. Dedicated 6Mbps		\$5,900	\$7,375	\$8,850	
c. Dedicated 10Mbps		\$7,850	\$9,810	\$11,772	
d. Upgrade to 29 Public Static IP Addresses		\$995	\$1,194	\$1,433	
Higher Bandwidth Services Available – Please call (888) 446-6911 for quote.					
3. Internet Equipment & Labor					
a. Switch Rental – up to 24 ports		\$185	\$225	\$270	
b. Patch Cable (up to 50') – Cat5e		\$50	\$62	\$74	
c. Labor / Floor Work – Fee Per Hour		\$125	\$125	\$125	
4. Voice Services: PBX Service – Domestic LD Included					
a. Single Line – <input type="checkbox"/> Instrument, <input type="checkbox"/> Non Dial 9, <input type="checkbox"/> Int'l LD		\$275	\$345	\$414	
b. Multi-line Phone w/ 1 main number & 1 rollover line		\$415	\$520	\$624	
c. Speaker Phone Line w/ Polycom Instrument		\$465	\$575	\$690	
5. Special Quote – Attachment A or Statement of Work (if applicable)					
6. Distance Fee of \$500 Internet / \$100 Telephone for each line outside the convention venue x (number of lines)					
For extension of 3rd party data circuits (ISDN, DSL, T-1, DS3, Ethernet) please call for quote.					
			SUBTOTAL		
			ESTIMATED 10% TAX / FEES		
			GRAND TOTAL		

Send Completed Orders with Payment and Floor Plan To:
 SMART CITY NETWORKS
 5795 W. Badura Avenue, Suite 110 Las Vegas, NV 89118
 (888) 446-6911 FAX (702) 943-6001 csr@smartcity.com

Effective January 1, 2017 – December 31, 2017

Customer No: **2017 - 024 -**

Network Security Declaration

Center: Minneapolis CC (024) - MN

Company Name: _____

Show: _____

Booth / Room #: _____

Customer / Ref #: 2017 - 024 -

The Network Security Policy implemented for this Facility requires Customer(s) adherence to several necessary precautions in order for Smart City to maintain a healthy, viable network for all Customers. This declaration of compliance with the security requirements as noted herein is an acknowledgement of Smart City's filtering policies and must be completed, signed by an authorized Customer representative and mailed or faxed to Smart City prior to the requested network service(s) being activated for Customer's usage.

Network Security Policy:

Smart City requires that all devices directly or indirectly accessing Smart City's network(s) have the latest virus scan software, Windows® security updates, system patches, and any other technological precautions necessary to protect the Customer(s) and others from viruses, malicious programs, and other disruptive applications. Any device(s) which adversely impacts Smart City's network(s) may cause service interruptions to Customer(s) which can lead to disconnection of the Customer's equipment from the network(s), with or without prior notice at Smart City's sole discretion. The device(s) in question will remain disconnected until all issues are adequately resolved. All charges will apply and no refunds will be given. Additional charges may apply for trouble diagnosis and / or problem resolution.

Smart City has implemented filtering policies on all Internet routers. These filters block all inbound Internet Control Message Protocol (ICMP) -- Ping, Traceroute, etc. -- destined to any Smart City Network(s). Smart City understands that Ping and Traceroute are valuable troubleshooting tools; therefore Smart City's Policy does allow ICMP (Ping & Traceroute) packets sourced from any Smart City network(s).

Further, to avoid infection by common Internet worms (Nachi, MSBlaster, LoveSAN, etc.), Smart City has implemented similar filters on the following TCP and UDP port numbers: UDP – 137, 138, 402, 1434 and TCP – 135, 139, 402, 445, 4444.

Customers requiring inbound or outbound access to any of the filtered ports, should contact a Smart City customer service representative in advance of the event with details of the specific requirements so that Smart City may consider the potential of a customized alternative.

Each Customer's business is important to Smart City and with advanced and timely notification of a Customer's needs we are confident that we can provide network services that perform as expected for all clients.

***** Please inform all show site personnel about the importance of Smart City's Network Security compliance issues *****

***** Services are activated after Smart City is in receipt of this signed declaration of compliance with our network security requirements *****

Device(s) Operating System: _____ Total # of Devices Connecting to Smart City's Network: _____

Type of Anti-Virus Software Installed: Norton McAfee Other: _____

Virus Scan Last Updated: _____ Date Security Updates Last Performed: _____ Date

Are You Renting Computers? Yes No Rental Company Name: _____

Rental Company Contact: _____ Contact Number: _____

With execution of this document the Customer hereby attests that Customer provided equipment, which will be connected to Smart City's network(s) at the above noted Facility and Show / Event has been properly protected, contains anti-virus software, and the latest patches and security updates have been installed. Customer(s) also accepts the responsibility for the performance of Customer's equipment and understands the conditions placed on service delivery by this document as well as the potential that additional charges may be incurred should Customer's equipment be found to adversely impact Smart City's network(s) performance. The Customer acknowledges that this Network Security Declaration is part of the Customer Contract allowing Smart City to provide requested service(s) and is subject to change without notice.

Signature _____

Date _____

Printed Name _____

Title _____

Floor Plan – Communications Cable

Center: Minneapolis CC (024) - MNCompany Name: ABC EXAMPLE COMPANYShow: ABC EXAMPLE SHOWBooth / Room #: 1234Customer / Ref #: 2017 - 024 - XXX - XXXX

Voice and Data communications cabling. Smart City is the **exclusive installer** of Voice and Data communications cabling. Smart City provides cabling to booths, within booths (under carpet and flooring) and from booth-to-booth. Fiber Optic, twisted pair (Category 3, 5 and 6), coaxial and all other data and telecommunication cable fall under Smart City's area of expertise.

IMPORTANT!! Prior to installation of service, a complete floor plan is required. Please utilize this grid should you not have your own floor plan to send us. You may use a different floor plan for each service group (Telephone, Internet, etc.) or combine all services on one floor plan. For a floor plan to be considered complete it **must** include all the information listed below (Main Distribution Location "MDL", designated location of items within the booth, surrounding booths, scale-length and width).

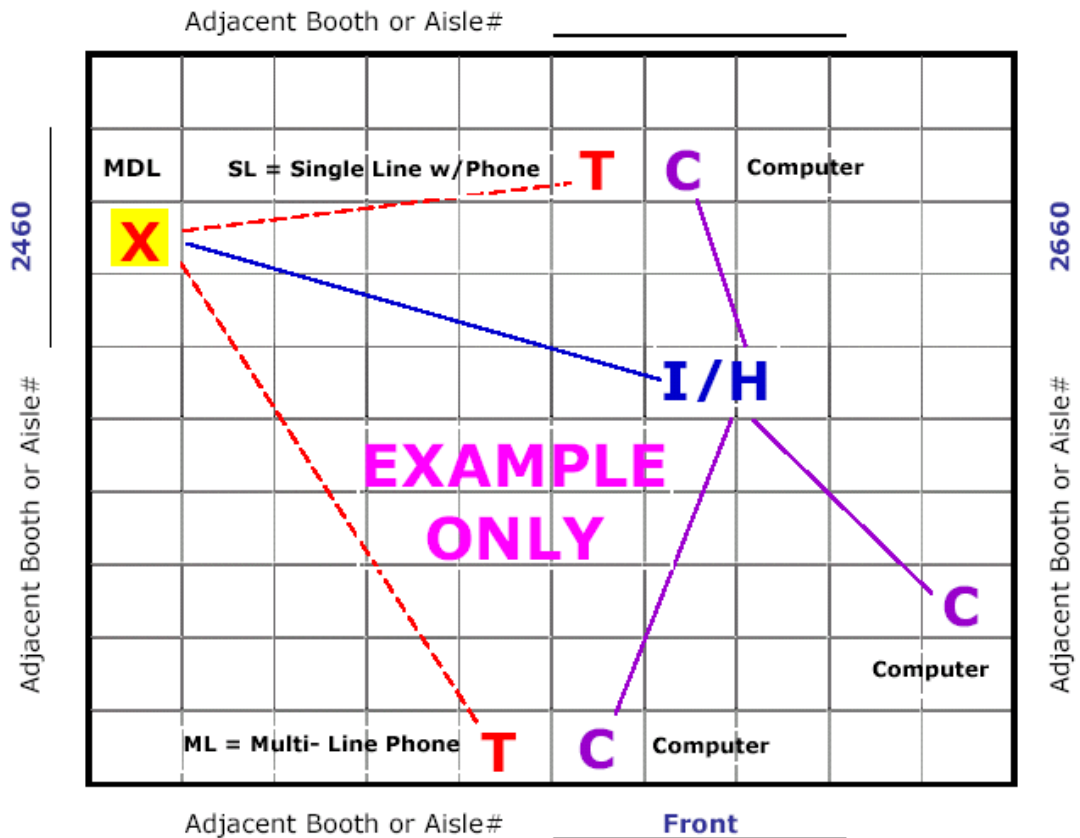

X = Main Distribution Location (**MDL**) – The originating line(s) for service, whether from overhead, a floor pocket or a column, will be delivered to a “**MDL**” before being distributed within your booth. Example: Storage area, back of booth, etc. (unless specified, the default for the “**MDL**” will be the back of the booth or at Smart City’s discretion, the most convenient location). All distribution of services to their final destination within the booth will originate from the “**MDL**”. A per line move fee will apply to relocate services within your booth after they have been engineered and / or installed.

T = Location of Telephones, Fax lines or other telecommunications equipment “**T**”.

I / H / PC / C = Location of primary Internet Service “**I**”, Hubs “**H**”, Patch Cables “**PC**” and / or Computers “**C**”. For Smart City to perform your floor work, you will need to indicate the location of each item you want cabled. Make sure to order your floor work, hubs, and patch cables early and in advance of the show moving in.

Orientation = The Booth or Aisle #'s surrounding your booth. A minimum of one surrounding Booth or Aisle # is required (two or more would be more helpful) for Smart City to accurately install your services.

Size = Booth dimensions (example 10x10) 20 x 20 . **Scale** = 1 Box is equal to 2 ft.



Minneapolis

Convention Center

1301 Second Avenue South
Minneapolis, Minnesota 55403-2781
(612) 335-6000

2017

Prices effective
1/1/17 thru 12/31/17



Exhibitor Service Information - (612) 335-6550
Fax - (612) 335-6600 TDD (612) 335-6500



CLEANING AND PORTER SERVICE ORDER FORM

ONLINE ORDERING AVAILABLE AT:
www.minneapolisconventioncenter.com

For your security DO NOT email credit card #

SAVE MONEY - DISCOUNTED ADVANCE RATE

Payment and order received by Convention Center fourteen (14) days prior to 1st show day

SAVE TIME

Send this form and payment directly to the Convention Center
Do not send these forms to the decorator

Pay all Convention Center Service Orders **with one Check** Payable to: **“Minneapolis Convention Center”**

AVOID CONFUSION

TO AVOID DOUBLE BILLING: When faxing a credit card order, **DO NOT** mail your original forms
Provide complete customer and payment information

Read instructions and policies on back of form

For mailed orders, please keep yellow copy, send one (1) copy to the Convention Center

DID YOU KNOW ??

OTHER SERVICES OFFERED AT THE MINNEAPOLIS CONVENTION CENTER:



Electrical Service



Plumbing/Compressed Air Service



Guest Services



Coffee and/or rolls in your booth. Contact the Convention Center Food Service at (612) 335-6045
and online @ www.kelber.com



Questions
Contact Exhibitor Services
(612) 335-6550



Minneapolis Convention Center
 1301 Second Avenue South
 Minneapolis, Minnesota 55403-2781
 (612) 335-6000 FAX (612) 335-6600
 Exhibitor Service Information (612) 335-6550

Cleaning and Porter Service Order Form

Prices Effective 1/1/17 thru 12/31/17 **2017**

Name of Event _____	Date of Event _____	Booth Number(s) _____
Firm Name _____ <small><input type="checkbox"/> Check if new address</small>	E-Mail Address _____	
Street Address _____	Contact Person _____	
City _____	State _____	Zip _____ Phone # _____

Payment Notice: **Advance Rates** apply only to orders paid in full and received 14 DAYS PRIOR TO THE FIRST SHOW DAY. **Standard Rates** must be paid at move-in for all other orders. NO EXCEPTIONS.

Notice: Cost of vacuuming will be invoiced on the total area of your booth. **100 sq. ft. minimum**
 Credits for cleaning must be requested prior to show opening each day. Requests for credit will not be honored after show opens.
 Convention Center staff will remove trash from Convention Center aisle containers on a daily basis.
 Should you require trash removal from your booth during show hours, please order porter service below.

Vacuuming

Booth Size _____ x _____ = _____ sq. ft. (100 sq. ft. minimum)	
COST PER DAY	Advance Rate 27¢/sq. ft.
	Standard Rate 32¢/sq. ft.
Number of Days _____ x _____ sq. ft. x rate \$ _____	Total \$ _____
	<small>(100 sq. ft. min.)</small>

Damp Mop

COST PER SQUARE FOOT	Advance Rate 45¢	Standard Rate 55¢
	_____ sq. ft. x rate \$ _____	
	<small>(100 sq. ft. min.)</small>	
Number of Days _____ x _____ sq. ft. x rate \$ _____	Total \$ _____	
	<small>(100 sq. ft. min.)</small>	

Periodic Porter Service

Porter service is provided every 2 hours (trash removal from booth during show hours). If you wish to have an attendant in your booth area on a full-time basis, please contact Exhibitor Services for rates and availability. Please remember to order a trash can from your decorator. The Convention Center does not supply trash cans.

	COST PER DAY	
	Advance Rate	Standard Rate
<input type="checkbox"/> 0-600 sq. ft.	\$ 52.00 per day	\$ 57.00 per day
<input type="checkbox"/> 600+ sq. ft.	\$ 100.00 per day	\$ 110.00 per day
Specify dates for service & number of days _____ x rate \$ _____	Total \$ _____	

Any balance due during or at the end of the show will be billed directly to the credit card number provided. By your signature below, you acknowledge and agree to these terms and authorize MCC to bill your credit card. **Please DO NOT email credit card #.**

Payment must be in U.S. Funds. Make checks payable to Minneapolis Convention Center.

Amer. Express Company Check or Money Order # _____

Discover Credit Card # _____ Exp Date _____

MasterCard Cardholders Name _____

Visa Authorized Signature _____

Order Total	\$
For MCC Use Only	
ID No. _____	\$ _____
Entered _____	Date _____
P.O. No. _____ P.O. needs to accompany order	

MINNEAPOLIS CONVENTION CENTER
1301 Second Avenue South - Minneapolis, Minnesota 55403-2781
Request for Cleaning and Porter Service
(612) 335-6550

IMPORTANT CONDITIONS AND REGULATIONS

1. ADVANCE ORDERS: To receive advance rate, orders must be received a minimum of 14 days prior to first show day.
2. **RETURNED CHECK FEE: A \$30.00 service charge will be assessed for any returned checks.**
3. CONDITIONS FOR PROCESSING SERVICE ORDER FORMS:
 - a. Payment **IN FULL, IN U.S. FUNDS** must accompany service order form.
 - b. Date payment is received by the Minneapolis Convention Center will determine the applicable rate.
 - c. All order form information must be completed in full for order to be processed. Incomplete order forms could result in processing delays resulting in slow service completion.
 - d. No service will be completed until full payment is received.
 - e. Cancellations:

Refunds will be computed as follows:

 1. After service - **NO REFUND.**
 2. 6 days or less prior to first scheduled move-in-day - **85% REFUND.**
 3. More than 6 days prior to first scheduled move-in day - **FULL REFUND.**
4. Claims will not be considered unless filed in writing by exhibitor prior to close of show.
5. Prices are based upon current wage rates and are subject to change without notice.



Minneapolis

Convention Center

1301 Second Avenue South
Minneapolis, Minnesota 55403-2781
(612) 335-6000

2017

Prices effective
1/1/17 thru 12/31/17



Exhibitor Service Information - (612) 335-6550
Fax - (612) 335-6600 TDD (612) 335-6500



COMPRESSED AIR - WATER - DRAIN - GAS SERVICE ORDER FORM

ONLINE ORDERING AVAILABLE AT:
www.minneapolisconventioncenter.com

For your security DO NOT email credit card #

SAVE MONEY - DISCOUNTED ADVANCE RATE

Payment and order received by Convention Center fourteen (14) days prior to 1st show day

SAVE TIME

Send this form and payment directly to the Convention Center
Do not send these forms to the decorator

Pay all Convention Center Service Orders **with one Check** Payable to: **“Minneapolis Convention Center”**

AVOID CONFUSION

TO AVOID DOUBLE BILLING: When faxing a credit card order, **DO NOT** mail your original forms
Provide complete customer and payment information

Read instructions and policies on back of form

For mailed orders, please keep yellow copy, send one (1) copy to the Convention Center

DID YOU KNOW ??

OTHER SERVICES OFFERED AT THE MINNEAPOLIS CONVENTION CENTER:



Electrical Service



Cleaning and Porter Service



Guest Services



Coffee and/or rolls in your booth. Contact the Convention Center Food Service at (612) 335-6045
and online @ www.kelber.com

Questions
Contact Exhibitor Services
(612) 335-6550





Minneapolis Convention Center
 1301 Second Avenue South
 Minneapolis, Minnesota 55403-2781
 (612) 335-6000 FAX (612) 335-6600
 Exhibitor Service Information (612) 335-6550

Compressed Air - Water - Drain - Gas Service Order Form

Prices Effective 1/1/17 thru 12/31/17 **2017**

Name of Event _____	Date of Event _____	Booth Number(s) _____
Firm Name _____	E-Mail Address _____	
<input type="checkbox"/> Check if new address		
Street Address _____	Contact Person _____	
City _____	State _____	Zip _____ Phone # _____

Payment Notice: Advance Rates apply only to orders paid in full and received 14 DAYS PRIOR TO THE FIRST SHOW DAY. Standard Rates must be paid at move-in for all other orders. NO EXCEPTIONS.

Compressed Air

Prices based on 1/2" line. Standard supplied connector is 1/4" or 1/2" Foster quick-disconnect type. Special adapters and multiple connections will require additional charges for parts & labor. Air pressure varies minimum 90 PSI to maximum 125 PSI. If moisture content and pressure are critical, exhibitor should bring drier and regulator.

Description	Qty.	Advance Rate	Standard Rate	
Service charge for 1st connection	_____	\$ 248.00	\$ 273.00	
Each additional connection	_____	100.00	152.00	
Lines above 1/2" in size, add 50% to service connection charge			\$ _____	
Size of air line required: _____ CFM required: _____				Total \$

24 hour Service Required? Add 50% to Service Connection Charge \$

Water Supply & Drain Connections

Note: Prices include only 10 ft. supply. Connection will require additional labor. Please call exhibitor services for estimates.

Description	Qty.	Advance Rate	Standard Rate	
Water (prices based on 1/2" line).				
Service charge for 1st 10 ft. of supply line (Drain not included)	_____	\$ 264.00	\$ 331.00	
Each additional supply line	_____	80.00	143.00	
Lines above 1/2" in size, add 50% to service charge			\$ _____	
Size of water line required: _____				Total \$

NOTE: Pressure may vary. Minimum pressure 45 PSI, maximum pressure 80 PSI. If pressure is critical, exhibitor should arrange to have a pressure regulator valve installed.

Description	Qty.	Advance Rate	Standard Rate	
Drainage (prices based on 3/4" line).				
Service charge for 1st 10 ft. of supply line (Water supply line not included)	_____	\$ 264.00	\$ 331.00	
Each additional supply line	_____	80.00	143.00	
Lines above 3/4" in size, add 50% to service charge			\$ _____	
Size of drainage line required: _____				Total \$

One-Time Water Fill and Drain

Description	Qty.	Advance Rate	Standard Rate	
Service charge for one time Fill and drain (< 500 gallon unit)	_____	\$ 138.00	\$ 179.00 each	
Fill and Drain (500 < 1,000 gallon unit)	_____	\$ 195.00	\$ 225.00 each	
Additional Units in same booth (< 500 gallon)	_____	\$ 70.00	\$ 85.00 each	
Additional Units in same booth (500 < 1,000 gallon unit)	_____	\$ 100.00	\$ 110.00 each	
Daily Top-off (< 500 gallon unit)	_____	\$ 25.00	\$ 35.00 each	
Daily Top-off (500 < 1,000 gallon unit)	_____	\$ 40.00	\$ 50.00 each	
**Services over 1,000 gallons				Total \$

**Call for pricing

Labor

Labor charge will be charged in 1/2 hour increments. (minimum charge of 1/2 hour)

Description	Rate	
Monday through Friday, 8:00 a.m. - 3:30 p.m. (except Holidays)	\$ 120.00/hr.	
Monday through Friday, 3:30 p.m. - Midnight (except Holidays)	\$ 180.00/hr.	
Monday through Friday, Midnight - 8:00 a.m., Saturday, Sunday and Holidays	\$ 240.00/hr.	
		Total \$

Natural Gas

All gas connections are located on south wall only. The Minneapolis Convention Center does not perform gas connections. You must use a qualified Minneapolis licensed pipefitter. Your cost will consist of our connection fee plus your payment to the pipefitter.

Description	Qty.	Advance Rate	Standard Rate	
Service charge for access	_____	\$ 234.00	\$ 354.00	Total \$

Any balance due during or at the end of the show will be billed directly to the credit card number provided. By your signature below, you acknowledge and agree to these terms and authorize MCC to bill your credit card. **Please DO NOT email credit card #.**

Payment must be in U.S. Funds. Make checks payable to Minneapolis Convention Center.

<input type="checkbox"/> Amer. Express	Company Check or Money Order # _____
<input type="checkbox"/> Discover	Credit Card # _____ Exp Date _____
<input type="checkbox"/> MasterCard	Cardholders Name _____
<input type="checkbox"/> Visa	Authorized Signature _____

Order Total \$

For MCC Use Only	
ID No. _____	\$ _____
Entered _____	Date _____
P.O. No. _____ P.O. needs to accompany order	

MINNEAPOLIS CONVENTION CENTER
 1301 Second Avenue South - Minneapolis, Minnesota 55403-2781
 Request for Compressed Air - Water - Drain - Gas Service
 (612) 335-6550

IMPORTANT CONDITIONS AND REGULATIONS

1. **ADVANCE ORDERS:** To receive advance rate, orders must be received a minimum of 14 days prior to first show day.
2. **RETURNED CHECK FEE: A \$30.00 service charge will be assessed for any returned checks.**
3. **CONDITIONS FOR PROCESSING SERVICE ORDER FORMS:**
 - a. Payment **IN FULL, IN U.S. FUNDS** must accompany service order form.
 - b. Date payment is received by the Minneapolis Convention Center will determine the applicable rate.
 - c. All order form information must be completed in full for order to be processed. Incomplete order forms could result in processing delays resulting in slow service installation.
 - d. No service will be installed until full payment is received.
 - e. Cancellations:
 Refunds will be computed as follows:
 1. After installation - **NO REFUND.**
 2. Before installation, but 6 days or less prior to first scheduled move-in-day - **85% REFUND.**
 3. Before installation and more than 6 days prior to first scheduled move-in day - **FULL REFUND.**
4. Rates quoted for all connections cover only the bringing of service to the booth in the most convenient manner as determined by the Minneapolis Convention Center and **DO NOT** include connecting equipment to provided services. Special placement or relocation of service will result in a labor charge. Payment **IN FULL** must be rendered for such services before the close of event day.
5.
 - a. Connection rates listed cover bringing service from main line to booth and do not include connecting equipment. Requests for special services such as placing hose under carpet or relocating service(s) will include a labor charge.
 - b. All work performed within booth attaching lines to equipment will be charged on a time and material basis in addition to connection fees.
 - c. A separate connection fee will be made for each piece of equipment using connected service, whether connected direct or otherwise.
6. Claims will not be considered unless filed in writing by exhibitor prior to close of show.
7. Unless otherwise directed, Minneapolis Convention Center Personnel are authorized to cut floor coverings to permit installation of service.
8. All material and equipment furnished by the Minneapolis Convention Center for this service order shall remain the Minneapolis Convention Center's property and shall be removed only by the Minneapolis Convention Center at the close of the show.
9. Wall, column and permanent building utility outlets are not a part of booth space and are not to be used by exhibitors.
10. All equipment must comply with federal, state and local safety codes.
11. Prices are based upon current wage rates and are subject to change without notice.
12. Under **NO** circumstances shall anyone other than "house personnel" make service connections.
13. Special equipment requiring company engineers or technicians for assembly, servicing, preparatory work and operation may be executed without "house personnel," however, all service connections to such equipment must be made by "house personnel" only.
14. The Minneapolis Convention Center reserves the right to refuse connection to any exhibitor whose equipment is deemed unsafe by Minneapolis Convention Center Management.
15. All equipment using water must have inlet and outlet properly tagged.
16. The Minneapolis Convention Center will not be responsible for moisture or water in air lines. Exhibitors should supply their own filter or other equipment to handle moisture or water.
17. The Minneapolis Convention Center must have 30 days notice in order to supply special regulators, strainers, traps, etc.
18. Service Outlet size will be determined by the volume required.



Minneapolis

Convention Center

1301 Second Avenue South
Minneapolis, Minnesota 55403-2781
(612) 335-6000

2017

Prices effective
1/1/17 thru 12/31/17

SECURITY
MEDICAL



POLICE
FIRE

Exhibitor Service Information - (612) 335-6550
Fax - (612) 335-6600 TDD (612) 335-6500

SECURITY
MEDICAL



POLICE
FIRE

GUEST AND SECURITY SERVICES ORDER FORM

ONLINE ORDERING AVAILABLE AT:
www.minneapolisconventioncenter.com

For your security DO NOT email credit card #

SAVE MONEY - DISCOUNTED ADVANCE RATE

Payment and order received by Convention Center fourteen (14) days prior to 1st show day

SAVE TIME

Send this form and payment directly to the Convention Center
Do not send these forms to the decorator

Pay all Convention Center Service Orders **with one Check** Payable to: **“Minneapolis Convention Center”**

AVOID CONFUSION





TO AVOID DOUBLE BILLING: When faxing a credit card order, **DO NOT** mail your original forms
Provide complete customer and payment information

Read instructions and policies on back of form

For mailed orders, please keep yellow copy, send one (1) copy to the Convention Center

DID YOU KNOW ??

OTHER SERVICES OFFERED AT THE MINNEAPOLIS CONVENTION CENTER:

-  Cleaning and Porter Service
-  Plumbing/Compressed Air Service
-  Electrical Service
-  Coffee and/or rolls in your booth. Contact the Convention Center Food Service at (612) 335-6045 and online @ www.kelber.com



Questions
Contact Guest and Security Services
(612) 335-6163



Minneapolis Convention Center
 1301 Second Avenue South
 Minneapolis, Minnesota 55403-2781
 (612) 335-6163 FAX (612) 335-6183
 Exhibitor Service Information (612) 335-6550

Guest and Security Services Order Form

Prices Effective 1/1/17 thru 12/31/17 **2017**

Name of Event _____			Date of Event _____		
Firm Name _____			Booth Number(s) _____		
Street Address _____			Contact Person _____		
City _____	State _____	Zip _____	Phone # _____		

Payment Notice: ADVANCED RATES apply only to orders Paid in full and received 14 DAYS PRIOR TO THE FIRST SHOW DAY. STANDARD RATES are for onsite requests and must be paid at move-in for all other orders. NO EXCEPTIONS.

Notice: All scheduled shifts have a four hour minimum. A supervisor may be required for shifts over 4 hours. Holiday rates apply. Booths that are staffed by more than one guard require a supervisor to break them. Holiday rates apply. Please provide date(s), time(s), and contact information in the space provided below.

Security

Security officer uniform options are a hard line or soft line uniform. Officers may work as civilian fire watch, loss prevention, executive detail, etc. Special arrangements and needs can be made by contacting Guest and Security Services at the number listed.

	Qty.	Total Hours	Advanced Rate	Standard Rate
Guard	_____ X	_____ X	\$25.00	\$37.00
Supervisor	_____ X	_____ X	\$26.00	\$39.00
				Total
				Tax 7.775%

Medical Services

Special arrangements and needs can be made by contacting Guest and Security Services at the number listed.

	Qty.	Total Hours	Advanced Rate	Standard Rate
EMT	_____ X	_____ X	\$40.00	\$58.00
				Total

Police Services

Special arrangements and needs can be made by contacting Guest and Security Services at the number listed.

	Qty.	Total Hours	Advanced Rate	Standard Rate
Police Officer	_____ X	_____ X	\$65.00	\$99.00
				Total

Order Total

Please provide a schedule of coverage, date(s), and time(s) here (if lengthy, please call Guest and Security Services at 612-335-6163):

Please provide a phone number and contact name for on-site approval of changes and additions

Any balance due during or at the end of the show will be billed directly to the credit card number provided. By your signature below, you acknowledge and agree to these terms and authorize MCC to bill your credit card. **Please DO NOT email credit card #.**

Payment must be in U.S. Funds. Make checks payable to Minneapolis Convention Center.

Amer. Express Company Check or Money Order # _____

Discover Credit Card # _____ Exp Date _____

MasterCard Cardholders Name _____

Visa Authorized Signature _____

Order Total \$

For MCC Use Only	
ID No. _____	\$ _____
Entered _____	Date _____
P.O. No. _____ P.O. needs to accompany order	

MINNEAPOLIS CONVENTION CENTER
1301 Second Avenue South - Minneapolis, Minnesota 55403-2781
Request for Guest Services
(612) 335-6163

IMPORTANT CONDITIONS AND REGULATIONS

1. **ADVANCE ORDERS:** To receive advance rate, orders must be received a minimum of 14 days prior to first show day.
2. **RETURNED CHECK FEE: A \$30.00 service charge will be assessed for any returned checks.**
3. **CONDITIONS FOR PROCESSING SERVICE ORDER FORMS:**
 - a. Payment **IN FULL, IN U.S. FUNDS** must accompany service order form.
 - b. Date payment is received by the Minneapolis Convention Center will determine the applicable rate.
 - c. All order form information must be completed in full for order to be processed. Incomplete order forms could result in processing delays resulting in slow service installation.
 - d. No service will be installed until full payment is received.
 - e. Cancellations:
Refunds will be computed as follows:
 1. After service - **NO REFUND.**
 2. Before service, but 6 days or less prior to first scheduled move-in-day - **85% REFUND.**
 3. Before service and more than 6 days prior to first scheduled move-in day - **FULL REFUND.**
4. Claims will not be considered unless filed in writing by exhibitor prior to close of show.
5. All material and equipment furnished by the Minneapolis Convention Center for this service order shall remain the Minneapolis Convention Center's property and shall be removed only by the Minneapolis Convention Center at the close of the show.
6. Prices are based upon current wage rates and are subject to change without notice.
7. A detailed description of duties must accompany all orders for service. Please provide this information to Guest Services at the number listed above.
8. If there are specific items that are to be protected, a detailed manifest of items is requested, so that an inventory control form may be established. Please provide this information to Guest Services at the number listed above.
9. A supervisor may be required for shifts exceeding 4 hours. In the case whereas more than ten employees are working, more supervisors may be necessary, Contact Guest Services for further information at the number provided above.
10. For fire code regulations concerning permits, equipment usage, open flame, etc., please contact Guest Services at the number listed above.
11. For specific law enforcement regulations, policies, procedures and laws, please refer to Guest Services at the number listed above.
12. Uniform change inquiries may be made through Guest Services.



Minneapolis Convention Center
 1301 Second Avenue South
 Minneapolis, Minnesota 55403-2781
 (612) 335-6167 FAX (612) 335-6600
 Exhibitor Service Information (612) 335-6550

Cable/Audio Visual Service Order Form

Prices Effective 1/1/17 thru 12/31/17 **2017**

Name of Event	Date of Event	Booth Number(s)
Firm Name		E-Mail Address
<input type="checkbox"/> Check if new address		
Street Address	Contact Person	
City	State	Zip
		Phone #

Payment Notice: Standard Rates must be paid at move-in for all other orders. NO EXCEPTIONS.

Equipment Rental	Standard Rate	Qty.	Days	Total
40" LCD Monitor (includes electrical service)	\$300.00/day	_____	_____	_____
52" LCD Monitor (includes electrical service)	\$400.00/day	_____	_____	_____
_____	_____	_____	_____	_____
_____	_____	_____	_____	_____

Equipment Rental	Standard Rate	Qty.	Per Event	Total
_____	_____	_____	_____	_____
_____	_____	_____	_____	_____

Cable Run Install/Remove: Sections below are dependent on placement of your booth in the Exhibit Hall.
 Client needs to provide their own cable.
 Please call Exhibitor Services at 612 335-6550 to determine applicable zone.

(BG-A)	\$550.00/Event	\$ _____
(BG-B)	\$650.00/Event	\$ _____
(YO-A)	\$700.00/Event	\$ _____
(YO-B)	\$800.00/Event	\$ _____

Note: Tax on equipment @ 7.75%. No tax on Labor or Cable Runs

Order Total	\$ _____
7.775% Tax	\$ _____ If applicable
Grand Total	\$ _____

Any balance due during or at the end of the show will be billed directly to the credit card number provided. By your signature below, you acknowledge and agree to these terms and authorize MCC to bill your credit card. **Please DO NOT email credit card #.**

Payment must be in U.S. Funds. Make checks payable to Minneapolis Convention Center.

<input type="checkbox"/> Amer. Express	Company Check or Money Order # _____
<input type="checkbox"/> Discover	Credit Card # _____ Exp Date _____
<input type="checkbox"/> MasterCard	Cardholders Name _____
<input type="checkbox"/> Visa	Authorized Signature _____

Order Total \$

For MCC Use Only	
ID No.	\$ _____
Entered	Date
P.O. No. P.O. needs to accompany order	